

Description

The AM1081-2 is a high dynamic range bypassable DC-coupled amplifier covering up to 8 GHz. The device exhibits low bypass insertion loss and a moderate positive gain-slope, providing frequency equalization useful in many broadband applications. Packaged in a 3mm QFN or a shielded module with internal 50Ω matching and requiring a single positive control voltage, the AM1081-2 represents a dramatic size reduction over a discrete implementation of a bypassable amplifier.

Features

- 17 dB Gain
- 2.5 dB Noise Figure
- +35 dBm OIP3
- +20 dBm P1dB
- +20 dBm PSat
- 1.25 dB Bypass Insertion Loss
- +5.0V, 83/1 mA (Gain/Bypass)
- +3.0V to +5.0V Supply Range
- +3.3V or +5V Logic Compatible
- 3mm QFN Package

Functional Diagram

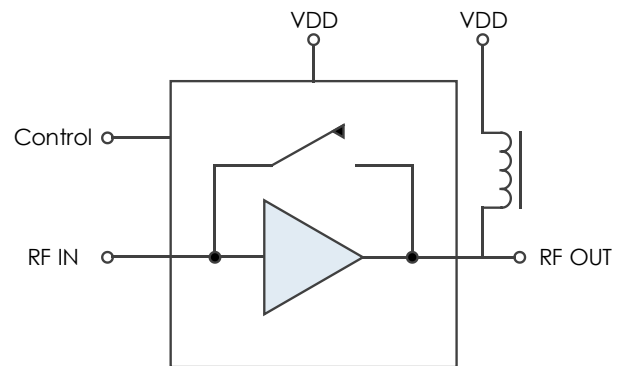

Characteristic Performance

(Data shown for Configuration A. See *Typical Application* section for more information.)

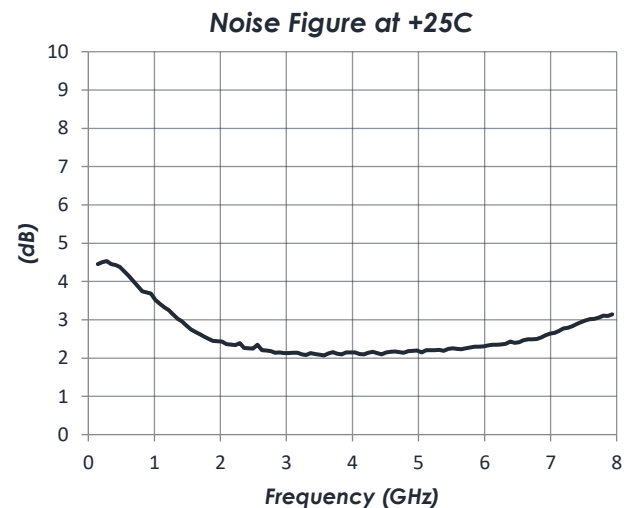
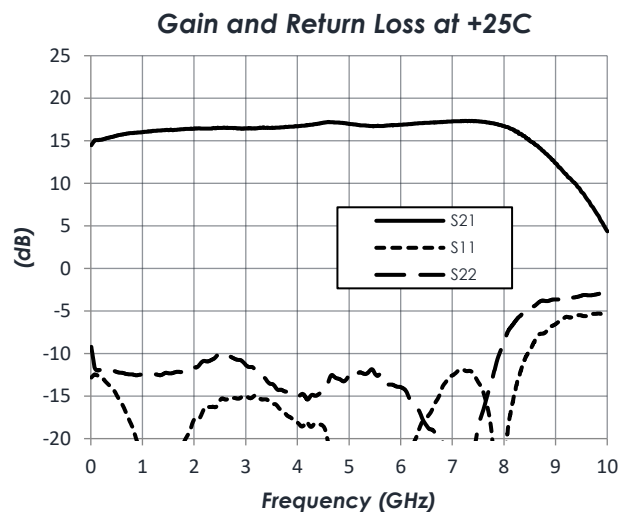

Table of Contents

Description	1	RF Performance	5
Features	1	State Table	5
Functional Diagram	1	Timing Characteristics	6
Characteristic Performance	1	Typical Performance – Configuration A..	7
Revision History	2	Typical Performance – Configuration B.	10
Pin Layout and Definitions	3	Typical Application	12
Specifications	4	Configuration A	12
Absolute Maximum Ratings	4	Configuration B	13
Handling Information	4	Part Ordering Details	14
Recommended Operating Conditions	4	Related Parts	14
Thermal Information	4	Evaluation PC Board	14
DC Electrical Characteristics	5	Component Compliance Information	15

Revision History

Date	Revision Number	Notes
June 28, 2021	1	Initial Release

Pin Layout and Definitions

NOTE: All Non-Named Pins Are NC or GND

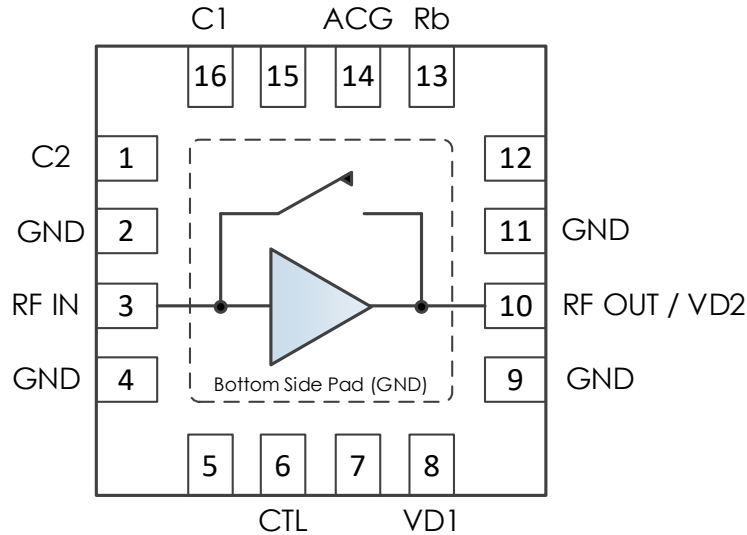

Pin Number	Pin Name	Pin Function
1	C2	External Capacitor Connection 2
2	GND	Ground – Common
3	RF IN	RF Input – 50 ohms – DC Coupled, External DC Block Required
4	GND	Ground – Common
5	NC	Not Connected *
6	CTL	Bypass/Amplifier Mode Control
7	NC	Not Connected *
8	VD1	DC Power Input
9	GND	Ground – Common
10	RF OUT/VD2	RF Output and DC Power Input – 50 Ohms – DC Coupled, External DC Block Required.
11	GND	Ground – Common
12	NC	Not Connected *
13	Rb	Config A: Do Not Connect (Floating) Config B: Ground
14	ACG	AC Ground
15	NC	Not Connected *
16	C1	External Capacitor Connection 1
Bottom Pad	GND	Ground – Common

*NC pins may be grounded or left open

Specifications

Absolute Maximum Ratings

	Minimum	Maximum
Supply Voltage	0.0 V	+6.0 V
RF Input Power		+20 dBm
Operating Junction Temperature	-40 C	+150 C
Storage Temperature Range	-50C	+150 C

Note: Any device operation beyond the Absolute Maximum Ratings may result in permanent damage to the device. The values listed in this table are extremes and do not imply functional operation of the device at these or any other conditions beyond what is listed under Recommended Operating Conditions. Any part subjected to conditions outside of what is recommended for an extended amount of time may suffer from reliability concerns.

Handling Information

	Minimum	Maximum
Storage Temperature Range (Recommended)	-50 C	+125 C
Moisture Sensitivity Level	MSL 3	



Atlanta Micro products are electrostatic sensitive.
Follow safe handling practices to avoid damage

Recommended Operating Conditions

	Minimum	Typical	Maximum
Supply Voltage	+3.0 V	+4.7 V	+5.2 V
Operating Case Temperature	-40 C		+85 C
Operating Junction Temperature	-40 C		+125 C

Thermal Information

	Thermal Resistance (°C / W)
Junction to Case Thermal Resistance (θ_{JC})	49.5

AM1081-2 – Amplifier

DC to 8 GHz Bypassable

DC Electrical Characteristics

(T = 25 °C unless otherwise specified)

Parameter	Configuration	Testing Conditions	Minimum	Typical	Maximum
DC Supply Voltage	A		+3.0 V	+5.0 V	+5.2 V
	B		+4.7 V	+5.0 V	+5.2 V
DC Supply Current	A	VDD = +5.0 V		81 mA	
	B	VDD = +5.0 V		53 mA	
Power Dissipated	A	VDD = +3.3 V		43 mA	
	A	VDD = +5.0 V		0.41 W	
	B	VDD = +5.0 V		0.27 W	
	A	VDD = +3.3 V		0.14 W	
Logic Level Low	A, B		-0.1 V		+0.4 V
Logic Level High	A, B		+2.2 V		+VDD
Control Current	A, B	CTL = +3.3V		115 μ A	
	A, B	CTL = +5.0V		200 μ A	

RF Performance

(T = 25 °C unless otherwise specified)

Parameter	Configuration	Testing Conditions	Minimum	Typical	Maximum
Frequency Range			DC		8 GHz
Gain	A	VDD = +5.0 V		17 dB	
	B	VDD = +5.0 V		17 dB	
	A	VDD = +3.3 V		16.5 dB	
Return Loss	A	VDD = +5.0 V		17 dB	
	B	VDD = +5.0 V		16.5 dB	
Bypass Insertion Loss	A, B	VDD = +5.0 V		2 dB	
Output IP3	A	VDD = +5.0 V		+35 dBm	
	B	VDD = +5.0 V		+32 dBm	
Output P1dB	A	VDD = +5.0 V		+19 dBm	
	B	VDD = +5.0 V		+17 dBm	
Noise Figure	A	VDD = +5.0 V		2.6 dB	
	B	VDD = +5.0 V		2.6 dB	

State Table

CTL	Amplifier
High	Enabled
Low	Bypassed

AM1081-2 – Amplifier

DC to 8 GHz Bypassable



Timing Characteristics

(T = 25 °C, VDD = +3.3V, CTL = 0.0V / +3.3V)

Switching Time	Minimum	Typical ²	Maximum
Amp On → Amp Bypass	125 ns	175 ns	300 ns
Amp Bypass → Amp On	700 ns	3.8 μs	7.0 μs

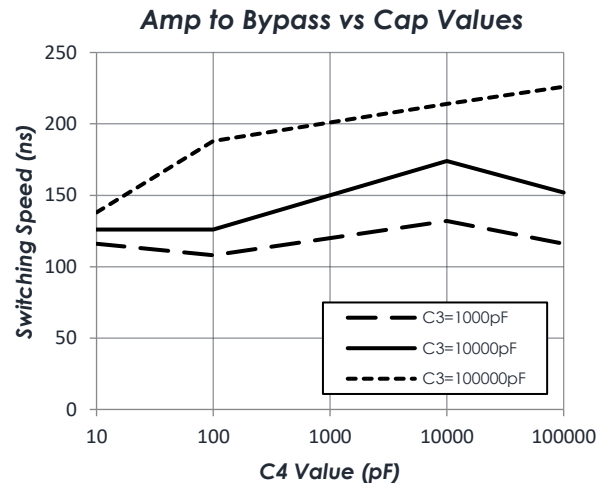
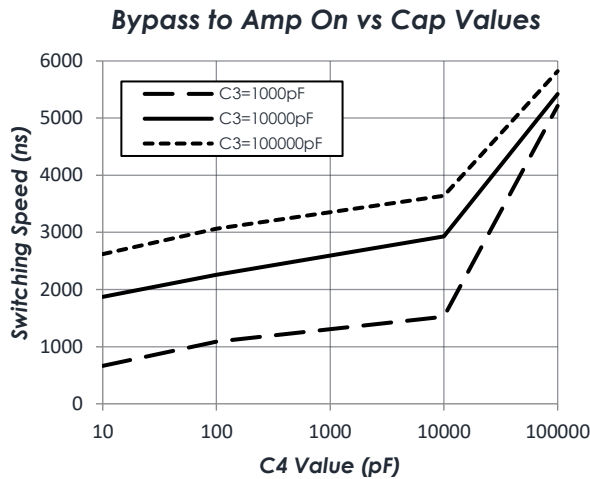

***Notes:**

1. Switching speeds measured as 50% trigger to 10%/90% RF respectively.
2. Typical measurements reflect switching speeds of amp as configured in Typical Application section.
3. To change times, alter value of C3 and C4 (see Typical Application section).

AM1081-2 – Amplifier

DC to 8 GHz Bypassable

Typical Performance – Configuration A

(Amplifier Enabled, VDD = +5.0 V, ID = 81mA)

Gain vs Temperature

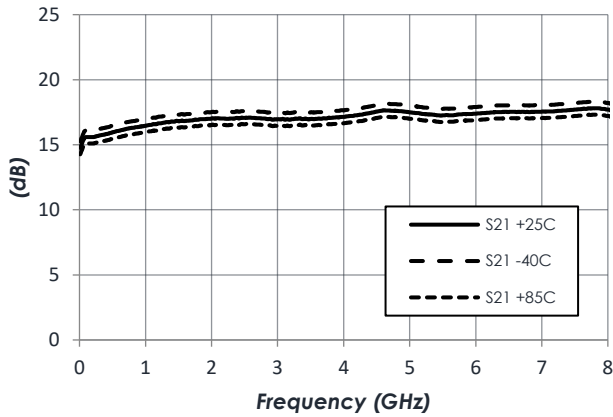

Noise Figure vs Temperature

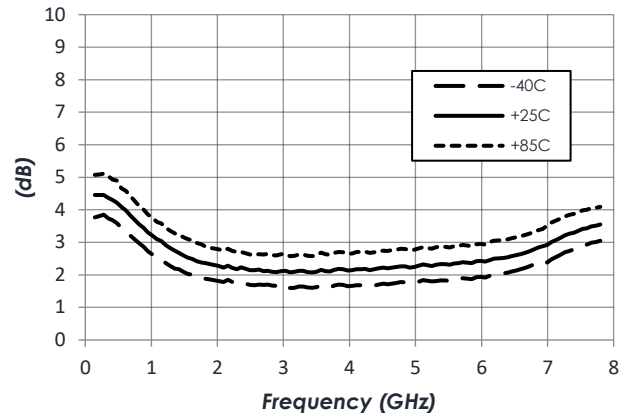

Output IP3 vs Temperature

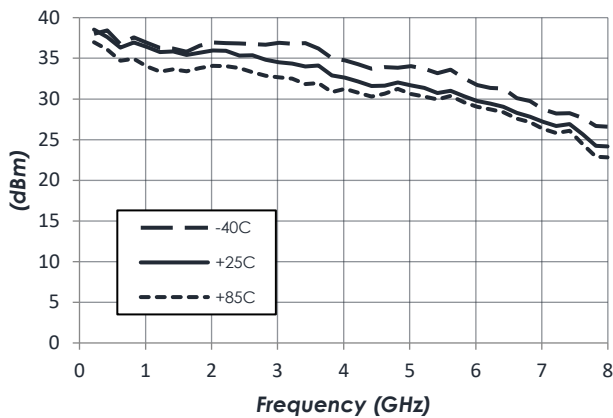

P1dB vs Temperature

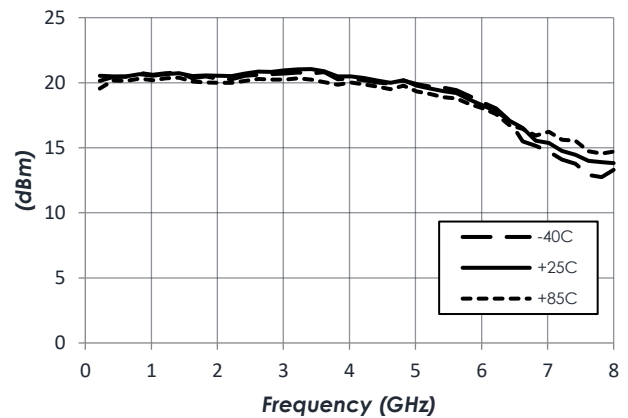

Reverse Isolation vs Temperature

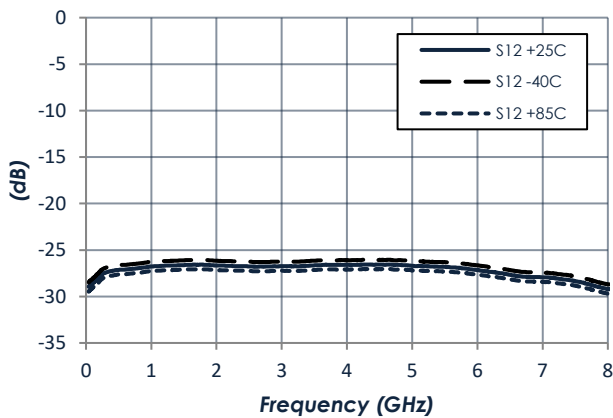

AM1081-2 – Amplifier

DC to 8 GHz Bypassable

Typical Performance – Configuration A (continued)

(Amplifier Enabled, VDD = +5.0 V, ID = 81mA)

P_{Sat} vs Temperature

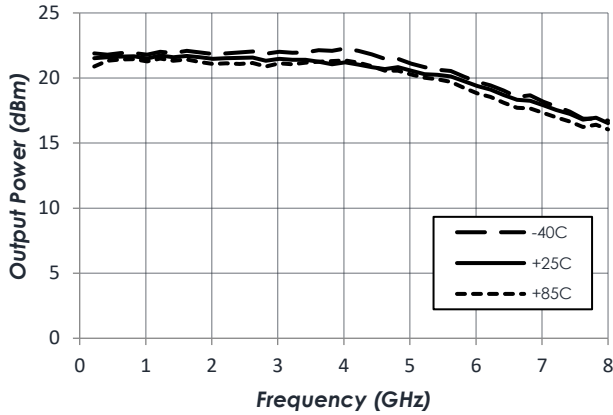

Pin vs. Pout at +25C

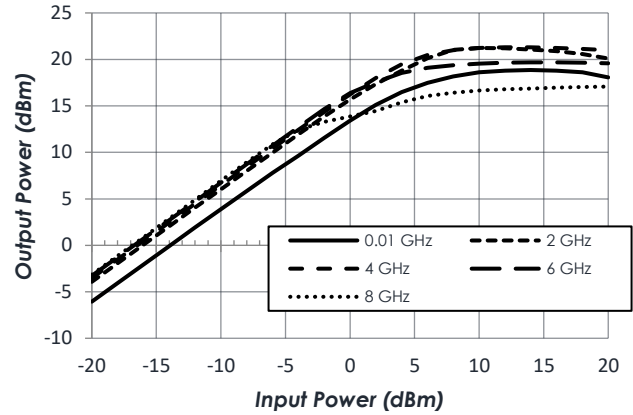

Pin vs. Pout at -40C

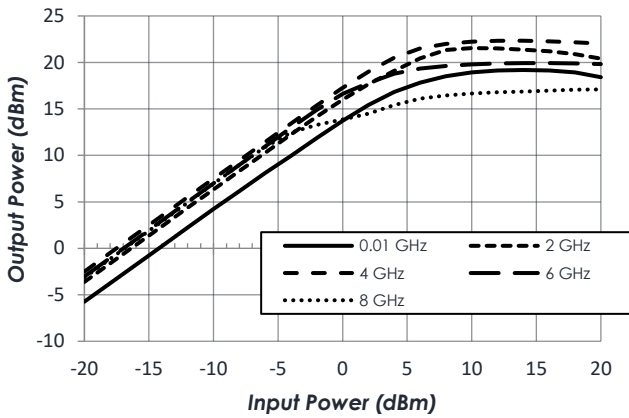

Pin vs. Pout at +85C

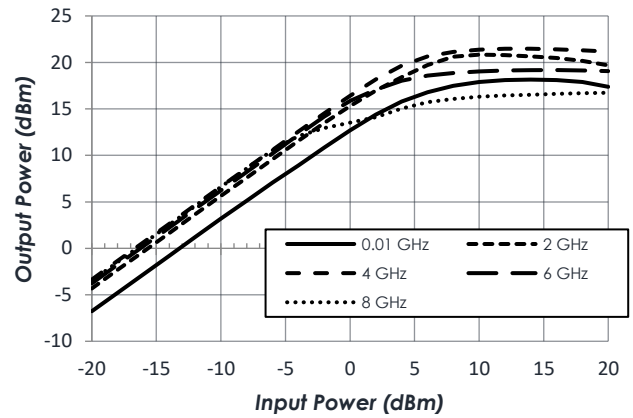

(Amplifier Bypass, VDD = +5.0 V, ID = 1 mA, Performance same as Configuration B)

Insertion and Return Loss at +25C

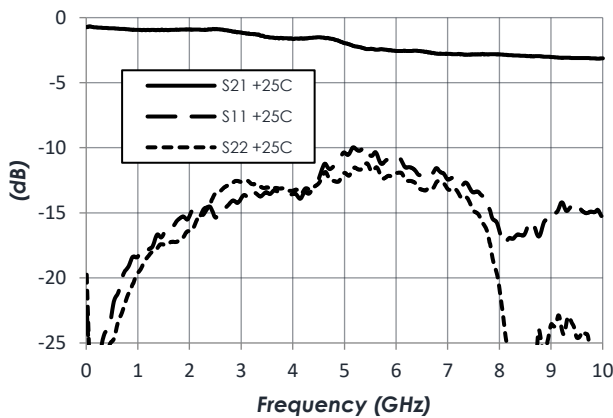

Insertion Loss vs Temperature

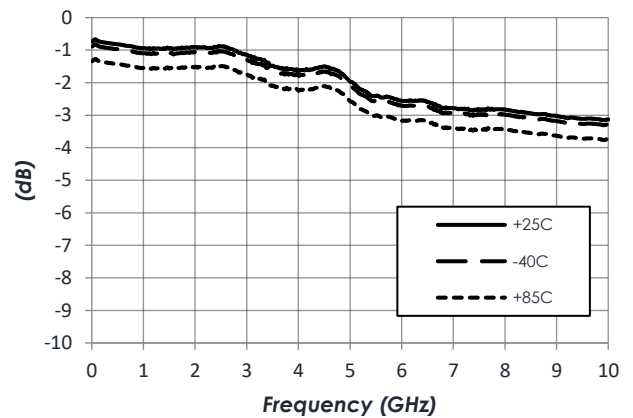

AM1081-2 – Amplifier

DC to 8 GHz Bypassable

Typical Performance – Configuration A (continued)

(T = 25 °C, Amplifier Enabled unless otherwise specified)

Gain vs VDD

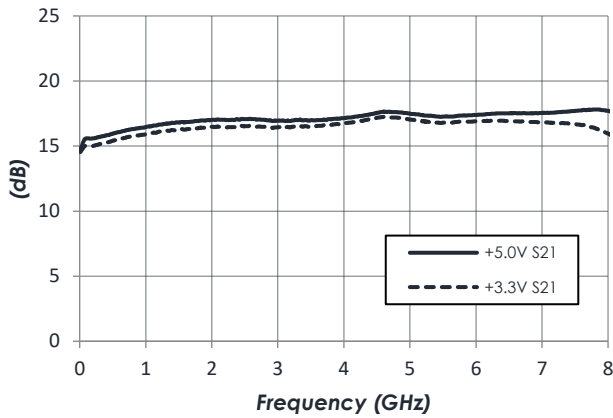

Noise Figure vs VDD

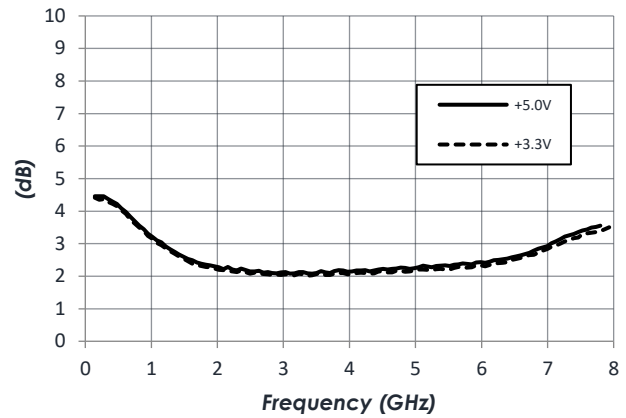

Output IP3 vs VDD

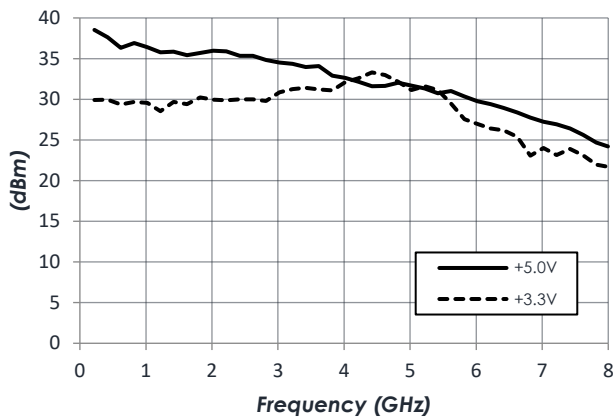

P1dB vs VDD

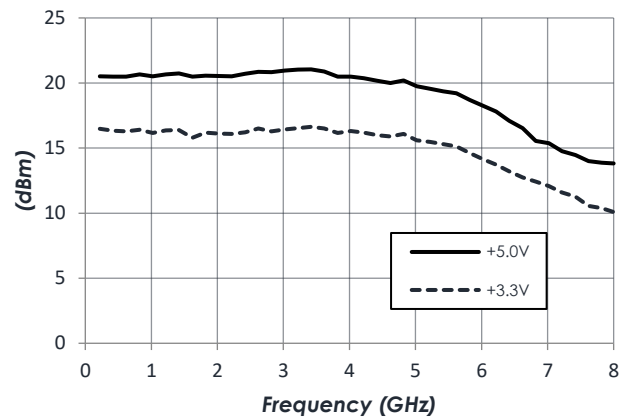

ID vs. VD2

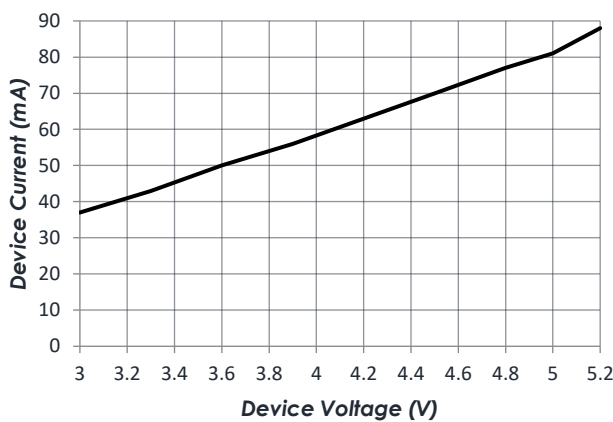

AM1081-2 – Amplifier

DC to 8 GHz Bypassable

Typical Performance – Configuration B

(Amplifier Enabled, VDD = +5.0 V, ID = 53mA)

Gain vs Temperature

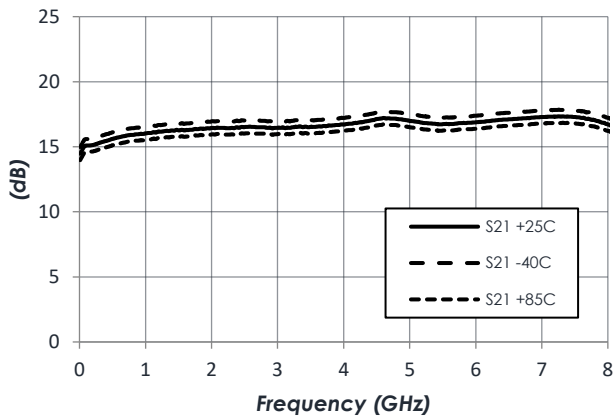

Noise Figure vs Temperature

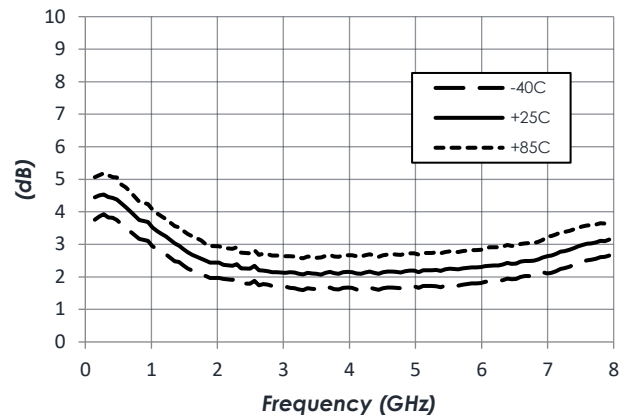

Output IP3 vs Temperature

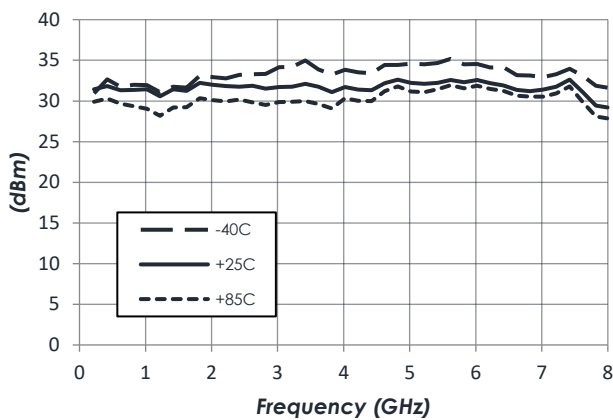

P1dB vs Temperature

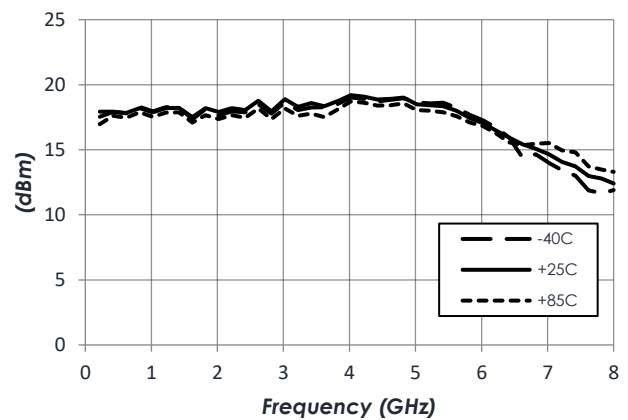

Reverse Isolation vs Temperature

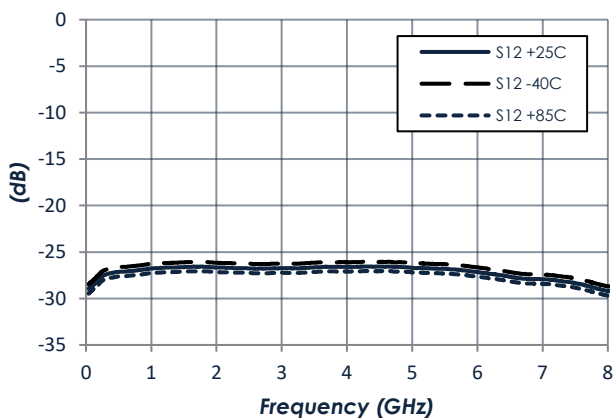

AM1081-2 – Amplifier

DC to 8 GHz Bypassable



Typical Performance – Configuration B (continued)

(Amplifier Enabled, VDD = +5.0 V, ID = 53mA)

P_{Sat} vs Temperature

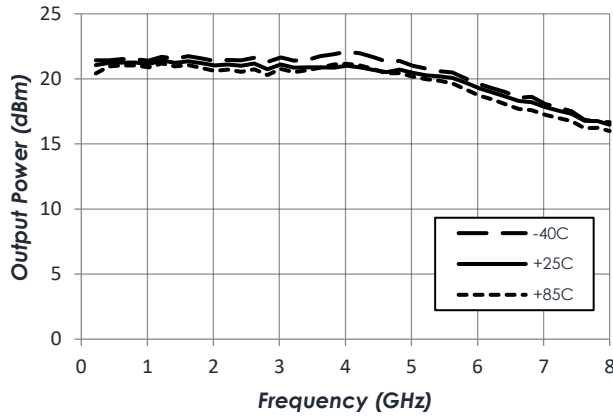

Pin vs. Pout at +25C

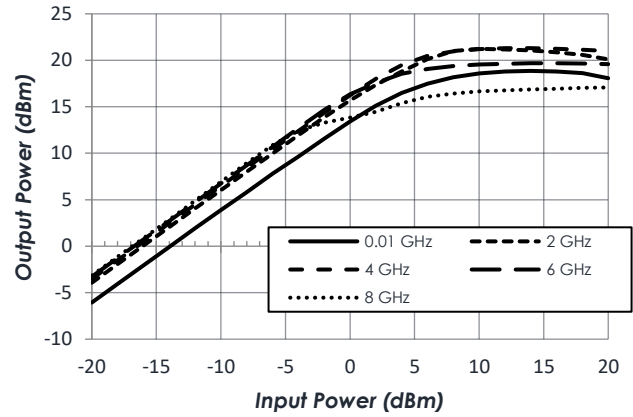

Pin vs. Pout at -40C

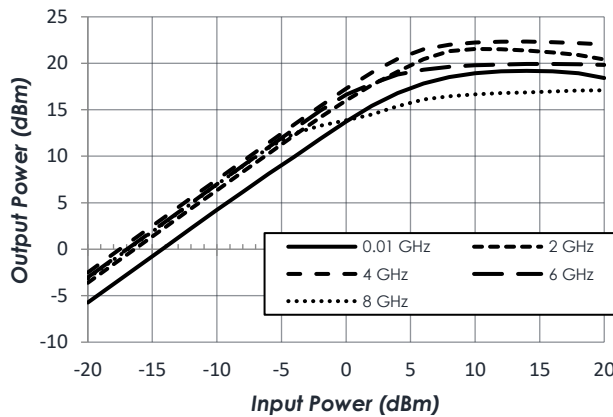

Pin vs. Pout at +85C

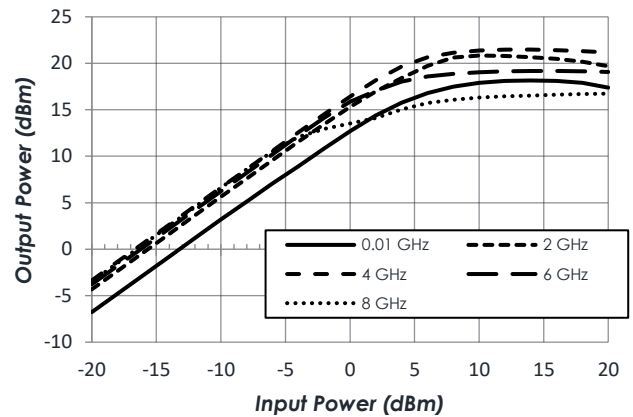

Typical Application

Configuration A

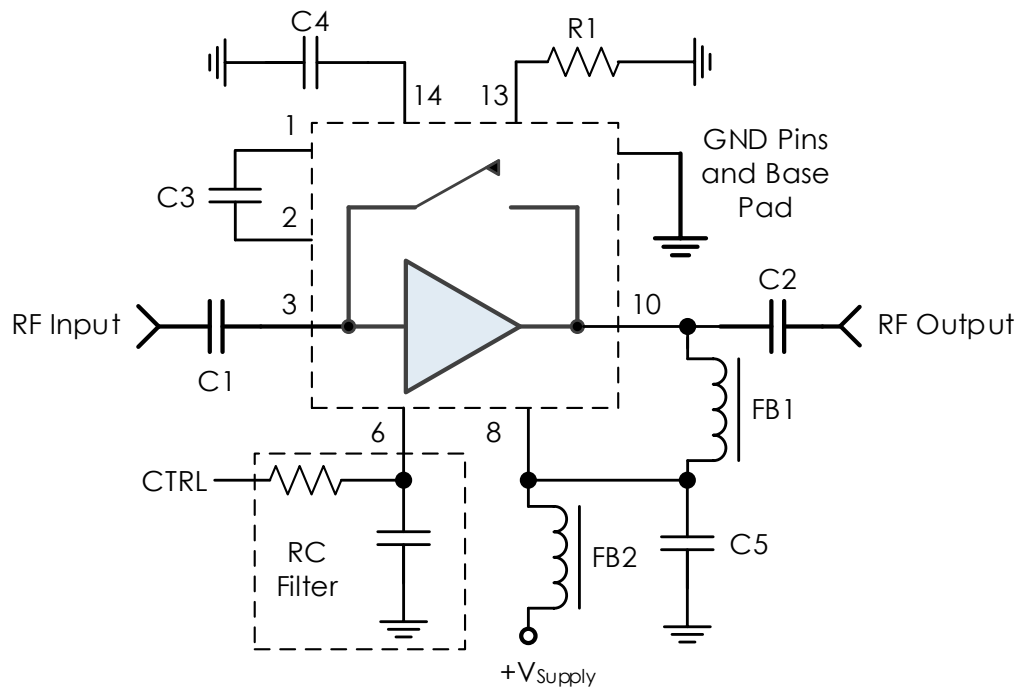

Recommended Component List (or equivalent):

Part	Value	Part Number	Manufacturer
C1, C2, C3	0.1 μ F	0201BB104KW250	Passives Plus
C4	10,000 pF	GRM033R61E103KA12D	Murata
C5	0.1 μ F	GCM155R71H104KE02J	Murata
FB1, FB2	-	MMZ1005A222E	TDK
R1	DNI	Do Not Install	-

Notes:

1. DC blocking capacitors C1 – C3 should be high performance, low-loss, broadband capacitors for optimum performance.
2. Select control line RC filter values based on desired logic source decoupling and switching speed
3. C3 and C4 should be placed as close to the AM1065 as possible to minimize PCB trace lengths. A 0201 package size is recommended to minimize stray PCB pad capacitance to ground.

Typical Application

Configuration B

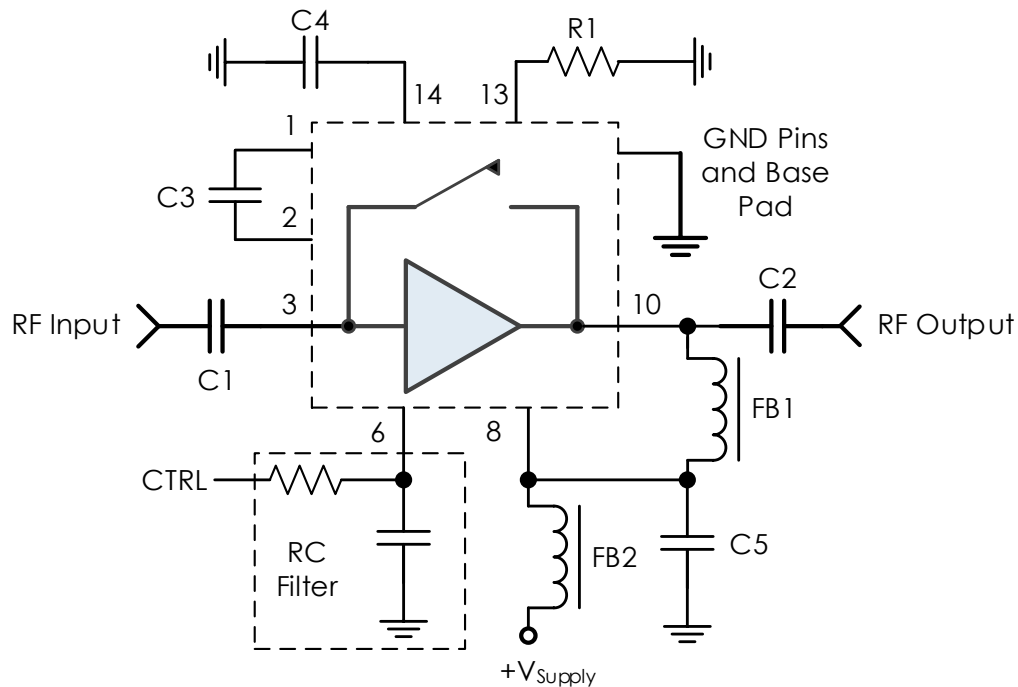

Recommended Component List (or equivalent):

Part	Value	Part Number	Manufacturer
C1, C2, C3	0.1 μ F	0201BB104KW250	Passives Plus
C4	10,000 pF	GRM033R61E103KA12D	Murata
C5	0.1 μ F	GCM155R71H104KE02J	Murata
FB1, FB2	-	MMZ1005A222E	TDK
R1	0 Ω	CRCW04020000Z0ED	Vishay

Notes:

1. DC blocking capacitors C1 – C3 should be high performance, low-loss, broadband capacitors for optimum performance.
2. Select control line RC filter values based on desired logic source decoupling and switching speed
3. C3 and C4 should be placed as close to the AM1065 as possible to minimize PCB trace lengths. A 0201 package size is recommended to minimize stray PCB pad capacitance to ground.

AM1081-2 – Amplifier

DC to 8 GHz Bypassable



Part Ordering Details

Description	Part Number
4mm 24 Lead QFN	AM1081
3mm 16 Lead QFN	AM1081-2
AM1081 Evaluation Board	AM1081 Eval
AM1081-2 Evaluation Board	AM1081-2 Eval
AM1081 in 0.95" x 1.13" x 0.6" RF-Shielded Module with Integrated Bias Tee and Field Replaceable SMA Connectors	AM1081-M

Related Parts

Part Number	Description
AM1065	DC to 8 GHz Bypassable Gain Block
AM1065-2	DC to 8 GHz Miniature Bypassable Gain Block
AM1081	DC to 8 GHz Bypassable Gain Block (Higher IP3)
AM1063-1	DC to 10 GHz Gain Block
AM1063-2	DC to 10 GHz Miniature Gain Block
AM1064-1	DC to 8 GHz Gain Block
AM1064-2	DC to 8 GHz Miniature Gain Block
AM1067	5 GHz to 20 GHz Bypassable Gain Block
AM1073	DC to 8 GHz Bidirectional / Bypassable Gain Block
AM1075	5 GHz to 26.5 GHz Bypassable Gain Block

Evaluation PC Board

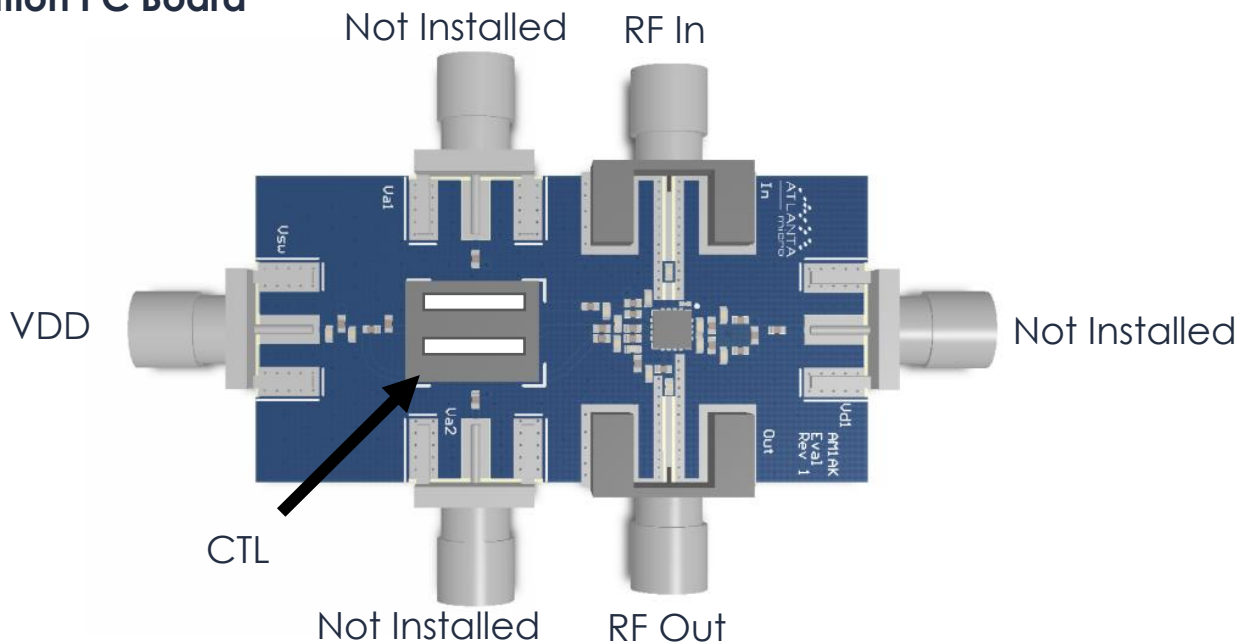

To obtain price, delivery, or to place an order contact sales@atlantamicro.com
 Atlanta Micro Inc., 3720 Davinci Ct, Suite 125, Norcross, GA 30092 • Phone: (470) 253-7640 • www.atlantamicro.com

Component Compliance Information

RoHS: Atlanta Micro, Inc. hereby certifies that all products comply with the EC Directive 2011/65/EC on the Restriction of Hazardous Substances, commonly known as EU-RoHS 6 and 10. All products supplied by Atlanta Micro shall be compliant with the European Directive 2011/65/EC based on the following substance list.

Substance List	Allowable Maximum Concentration
Lead (Pb)	<1000 PPM (0.1% by weight)
Mercury (Hg)	<1000 PPM (0.1% by weight)
Cadmium (Cd)	<75 PPM (0.0075% by weight)
Hexavalent Chromium (CrVI)	<1000 PPM (0.1% by weight)
Polybrominated Biphenyls (PBB)	<1000 PPM (0.1% by weight)
Polybrominated Diphenyl ethers (PBDE)	<1000 PPM (0.1% by weight)
Decabromodiphenyl Deca BDE	<1000 PPM (0.1% by weight)
Bis (2-ethylhexyl) Phthalate (DEHP)	<1000 PPM (0.1% by weight)
Butyl Benzyl Phthalate (BBP)	<1000 PPM (0.1% by weight)
Dibutyl Phthalate (DBP)	<1000 PPM (0.1% by weight)
Diisobutyl Phthalate (DIBP)	<1000 PPM (0.1% by weight)

REACH: Atlanta Micro, Inc. neither uses nor intentionally adds any of the substances considered to be a Substance of Very High Concern (SVHC) as defined by the EU Regulation (EC) No. 1907-2006 on Registration, Evaluation, Authorization, and Restriction of Chemicals (REACH).

Conflict Materials: Atlanta Micro does not knowingly use materials that are sourced from the Democratic Republic of Congo (DRC) or any other known conflict regions. Atlanta Micro's supply chain is comprised of sources that are both environmentally and socially responsible. We periodically review this requirement with our vendors to ensure continued compliance.

Atlanta Micro takes its responsibility as a global partner seriously and will use due diligence within our supply chain to ensure all standards are met to the best of our knowledge.