

Medical / Industrial AC-DC Power Supply

600 W Convection Cooling / MEU-600C series



Highlights & Features

- Convection Cooled
- Up to 600 Watt in 5" x 8" x 1.57" Package
- Up to 9.5 W/inch³ Power Density
- Full Power from 90 V to 264 V
- Full Power up to 50°C Ambient
- Up to 500 KHrs MTBF
- 2 MOPP Isolation
- Suited for Type BF Medical Products.
- 5 V/1 A Standby Output
- 12 V/0.6 A Fan Output for System
- Optional CV/CC Version
- Current Sharing
- Conformal Coating
- Class B Conducted and Radiated EMI
- IEC60601-1-2 4th Edition Immunity Compliance
- Normal and Reversed Option for Remote On/Off and Power Good Signal
- Analog and Digital Voltage Adjustment
- PMBus Ver 1.3 Supported
- Optional RS485 Version

Safety Certifications

- IEC 60601-1 2nd edition and IEC 60601-1 3rd edition + A1 CB report
- TUV EN 60601-1:2006/A11/A12
- UL 60601-1+CAN/CSA 60601-1: (Ed.3.2005)
- IEC 60950-1, IEC 62368-1 CB report
- TUV EN 60950-1, EN 62368-1
- UL 60950-1+CAN/CSA 60950-1, UL 62368-1+CAN/CSA 62368-1

Input	
Input Voltage	85 VAC ~ 264 VAC
Input Frequency	47 Hz ~ 63 Hz
Input Current	<7.5 A
Inrush Current	<55 A
Power Factor	>0.95 @ rated load
Efficiency	Up to 94%
Patient Leakage Current	<100 uA normal, <500 uA SFC
Earth Leakage Current	<300 uA normal, <1 mA SFC
Output	
Output Voltage	24 V 48 V
Output Current	0-25.0 A 0-12.5 A
Ripple & Noise	<1% Vrated pk-pk
Auxiliary Power	5 V / 1 A (No minimum load required)
Fan Output	12 V / 0.6 A
Environmental	
MTBF	500 KHrs
Operation Temperature	-20°C ~70°C ¹⁾
Operation Altitude	5000 m or 54 kPa

1) Power de-rating with temperature above 50°C, refer to power de-rating curve for detail

Medical / Industrial AC-DC Power Supply

600 W Convection Cooling / MEU-600C series

Model Information

Model Number	Input Voltage	Output Voltage	Current Output
MEU-600C24T AAA	85-264 Vac	24 Vdc	0-25.0 A
MEU-600C48T AAA	85-264 Vac	48 Vdc	0-12.5 A

Model Numbering

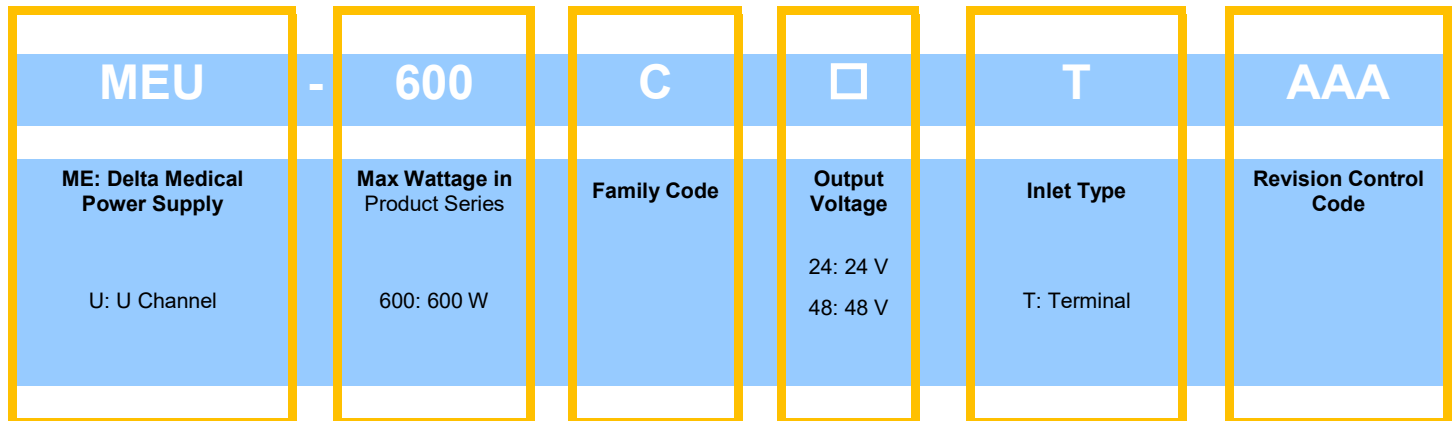

Medical / Industrial AC-DC Power Supply

600 W Convection Cooling / MEU-600C series

Specifications

Input Ratings / Characteristics

Nominal Input Voltage	100-240 Vac
Input Voltage Range	85-264 Vac
Nominal Input Frequency	50-60 Hz
Input Frequency Range	47-63 Hz
Input Current (max)	7.5 A
Input Surge Voltage (max)	300 Vac for 100 ms
Full load Efficiency	(typ. For 24 V output Model) 92.5% @ 115 Vac/60 Hz 94% @ 230 Vac/50 Hz, Reference Fig. 1 (typ. For 48 V output Model) 94% @ 115 Vac/60 Hz 95% @ 230 Vac/50 Hz, Reference Fig. 1-1
Inrush Current (max)	55 A @ 264 Vac, cold/hot start
Input-PE (protective earth) leakage current (max)	0.3 mA @ NC, 1 mA @ SFC ¹⁾
Output-PE (protective earth) leakage current for Type BF application (max)	0.1 mA @ NC, 0.5 mA @ SFC ¹⁾
Power Factor (min)	0.95 @ 115 V/50 Hz, 230 V/50 Hz, full load

1) NC: normal condition, SFC: single fault condition

Leakage Current		100 Vac/60 Hz (Typ)	264 Vac/60 Hz(Typ)	Delta Limit	IEC60601-1 Limit
Input-PE Leakage Current	Normal Condition	108	281	300 uA max	5000 uA max
	Single Fault Condition	213	550	1000 uA max	10000 uA max
Output-PE Leakage Current for Type BF application	Normal Condition	34	87	100 uA max	100 uA max
	Single Fault Condition	84	222	500 uA max	500 uA max

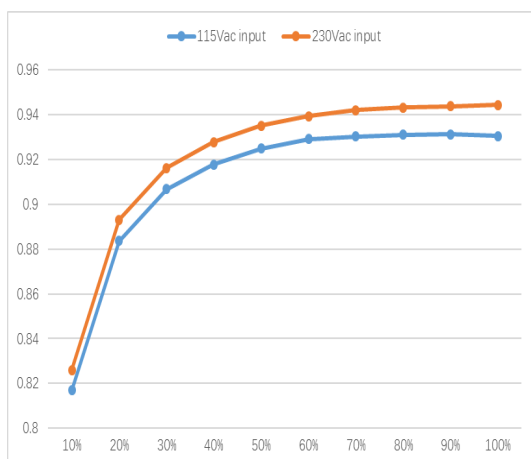

Figure 1. Typical efficiency Curve for 24V (600W max)

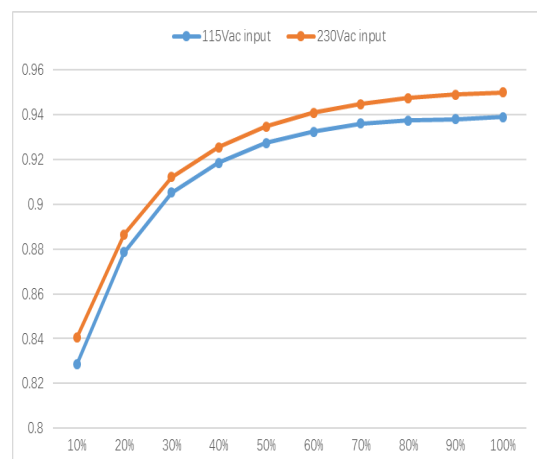

Figure 1-1. Typical efficiency Curve for 48V (600W max)

Medical / Industrial AC-DC Power Supply

600 W Convection Cooling / MEU-600C series

Output Ratings / Characteristics

Total Regulation	±3%
Output Power (max)	600 W
Line Regulation (max)	1%
Load Regulation (max)	2%
Ripple & Noise (typ.)	1% pk-pk Vrated @ rated load, Reference Fig. 2
Voltage Trimming Range	±10% Vrated
Dynamic Response (Overshoot & Undershoot O/P Voltage)	±5% @ with 50-100% load change
Start-up Time (max)	2000 ms @ 115 Vac
Hold-up Time (min)	20 ms @ 600 W, with nominal input range
Capacitive load (max)	6000 uF
Rise time (max)	<50 ms
Remote Sense	Up to 500 mV compensation for voltage drop across external wire connections to load. Short and reverse connection protected.

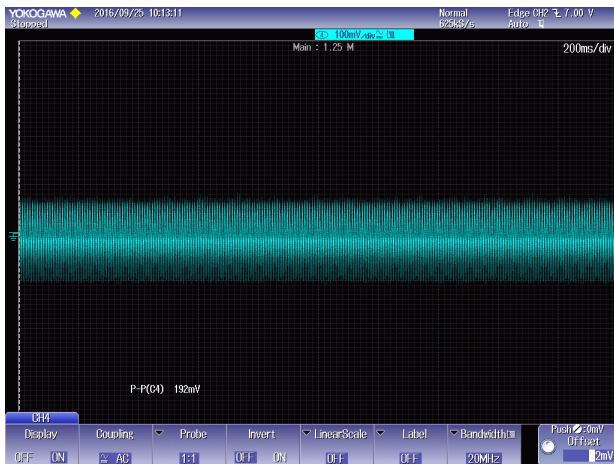

(a) 115 V (measured value=190 mV)

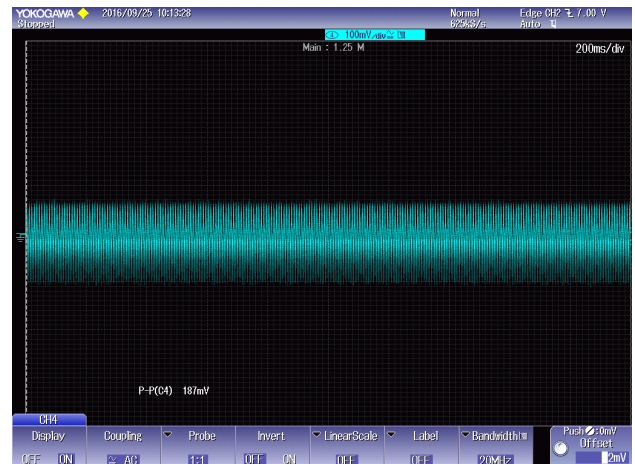

(b) 230 V (measured value=187 mV)

Figure 2. 24 V output model Ripple & Noise example, 20 MHz BW

Nominal Output Voltage of standby output (Vstby)	5 V
Nominal Output Current of standby output	1 A
Total Regulation of standby output	±3%
Ripple & Noise of standby output	100 mV max

Nominal Output Voltage of Fan Output (Vfan)	12 V
Nominal Output Current of Fan Output	0.6 A
Total Regulation of Fan Output	±5%
Ripple & Noise of Fan Output	120 mV max

Medical / Industrial AC-DC Power Supply

600 W Convection Cooling / MEU-600C series

Ripple & Noise measurement circuit

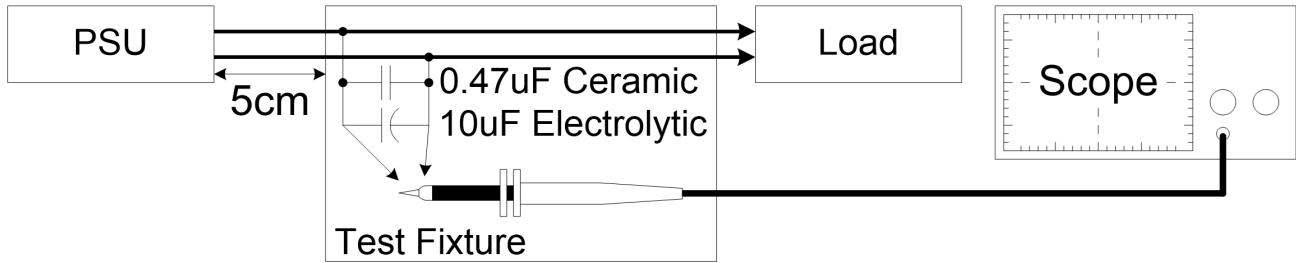

Figure 3. Ripple & Noise testing setup

Mechanical

Package	U Channel
Dimensions (L x W x H)	203.2 x 127 x 40 mm (8 x 5 x 1.57 inch)
Unit Weight	1.3 kg (2.87 lb)

Environment

Surrounding Air Temperature	Operating	Absolute Maximum/Minimum Rating. -20°C to +70°C. Linear power derate from 100% load at 50°C, to 50% load at 70°C Note: see power de-rating curves below
	Storage	-40°C to +85°C
Operating Humidity	5-95% RH (Non-Condensing)	
Operating Altitude	Up to 5,000 meters (up to 16,400 feet or 106-54kPa)	
Non-Operating Altitude	Up to 5,575 meters (up to 18,290 feet or 106-50kPa)	
Shock Test (Non-Operating)	50 G, 11 ms, 3 shocks for each direction	
Vibration (Operating)	5-500 Hz, 2 Grms, 15 minute for each three axis	

Power De-rating curve

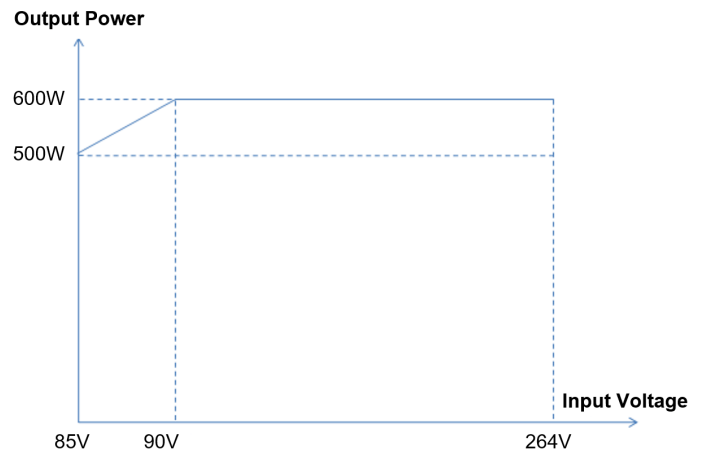
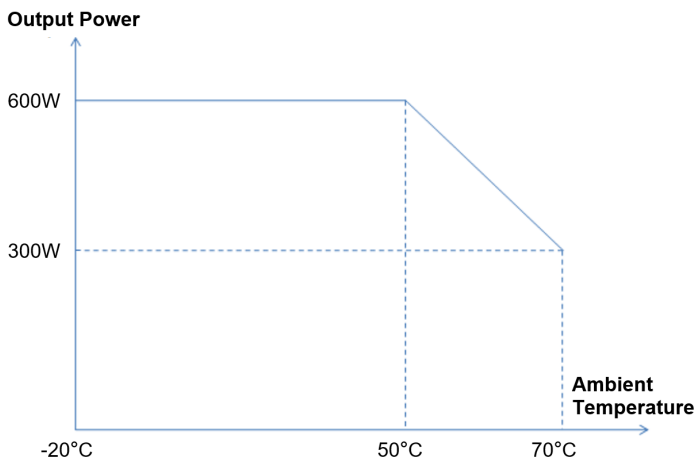

Medical / Industrial AC-DC Power Supply

600 W Convection Cooling / MEU-600C series

Protections (for both main output and 5Volt Standby outputs, unless otherwise indicated)

Overvoltage (max)	Main output 140% of rated normal voltage, Latch Mode Standby 125% of rated voltage, Latch Mode
Over load / Over current (max)	Main output 160% of rated current Standby 2 A max Hiccup Mode (Non-Latching, Auto-Recovery) Fan Output 1.5 A max with current limiting protection
Over Temperature	Latch Mode for Main output
Short Circuit	Hiccup Mode (Non-Latching, Auto-Recovery)

Reliability Data

MTBF (Minimum) at 115 Vac, Full Load, 35 °C	500 Khrs based on Telecordia SR-332
Operating life (Minimum) at 115 Vac, Full Load, 25°C	26,280 hrs

Safety Standards / Directives

Medical Safety	IEC 60601-1 2 nd and 3 rd +A1 edition CB report TUV EN60601-1:2006 UL 60601-1+CAN/CSA 60601-1: (Ed.3.2005)	
ITE Safety	IEC 60950-1, IEC 62368-1 CB report TUV EN 60950-1, EN 62368-1 UL 60950-1+CAN/CSA 60950-1, UL 62368-1+CAN/CSA 62368-1	
CE	In conformance with EMC Directive 2014/30/EU and Low Voltage Directive 2014/35/EU EN 60601-1: 2006 + A11: 2011 + A1: 2013 + A12: 2014 & EN 60601-1-2: 2015	
UKCA	In conformance with Electrical Equipment (Safety) Regulations 2016, and Electromagnetic Compatibility Regulations 2016, Medical Devices Regulations 2002(UK MDR 2002)	
Galvanic Isolation	Input to/Output (2XMOPP)	4000 Vac
	Input to/Ground (1XMOPP)	1500 Vac
	Output to/Ground (1XMOPP)	1500 Vac (Type BF application rated)

Medical / Industrial AC-DC Power Supply

600 W Convection Cooling / MEU-600C series

EMC

EMC / Emissions		EN/BS EN 55011, EN/BS EN 55032, FCC Title 47:Class B
Harmonic Current Emissions	IEC 61000-3-2	Meet Class D limit
Immunity to		
Voltage Flicker	IEC 61000-3-3	
Electrostatic Discharge	IEC 61000-4-2	Level 4 Criteria A ¹⁾⁵⁾ Air Discharge: 15 kV Contact Discharge: 8 kV
Radiated Field	IEC 61000-4-3	Criteria A ¹⁾ 80 MHz-2700 MHz, 10 V/m AM modulation Level 2 Criteria A ¹⁾⁵⁾ 385 MHz-5785 MHz, 28 V/m Pulse mode and other modulation
Electrical Fast Transient / Burst	IEC 61000-4-4	Level 3 Criteria A ¹⁾ : 2 kV
Surge	IEC 61000-4-5	Level 3 Criteria A ¹⁾⁵⁾ Common Mode ³⁾ : 2 kV Differential Mode ⁴⁾ : 1 kV
Conducted	IEC 61000-4-6	Level 2 Criteria A ¹⁾⁵⁾ 150 kHz-80 MHz, 3 Vrms, 6 Vrms at ISM bands and Amateur radio bands
Power Frequency Magnetic Fields	IEC 61000-4-8	Criteria A ¹⁾⁵⁾ Magnetic field strength 30 A/m
Voltage Dips	IEC 61000-4-11	30% 10 ms Criteria A ¹⁾ 60% 100 ms Criteria B ²⁾ 100% 5000 ms Criteria B ²⁾
Voltage Dips ⁵⁾	IEC 60601-1-2	Criteria A ¹⁾ 0% U _T , 0.5 cycle (10 ms) (0°, 45°, 90°, 135°, 180°, 225°, 270°, 315°, 360°) Criteria B ²⁾ , can meet Criteria A with 500 W load or lower 0% U _T , 1 cycle (20 ms), 0° Criteria B ²⁾ 70% U _T , 25 cycle (500 ms), 0° Criteria B ²⁾ 70% U _T , 250 cycle (5000 ms), 0°

- 1) Criteria A: Normal performance within the specification limits
- 2) Criteria B: Output out of regulation, or shuts down during test. Automatically restored to normal operation after test.
- 3) Asymmetrical: Common mode (Line to earth)
- 4) Symmetrical: Differential mode (Line to line)
- 5) Compliant with IEC60601-1-2 4th Edition

Medical / Industrial AC-DC Power Supply

600 W Convection Cooling / MEU-600C series

Dimensions

Mechanical Drawing (MEU-600C)

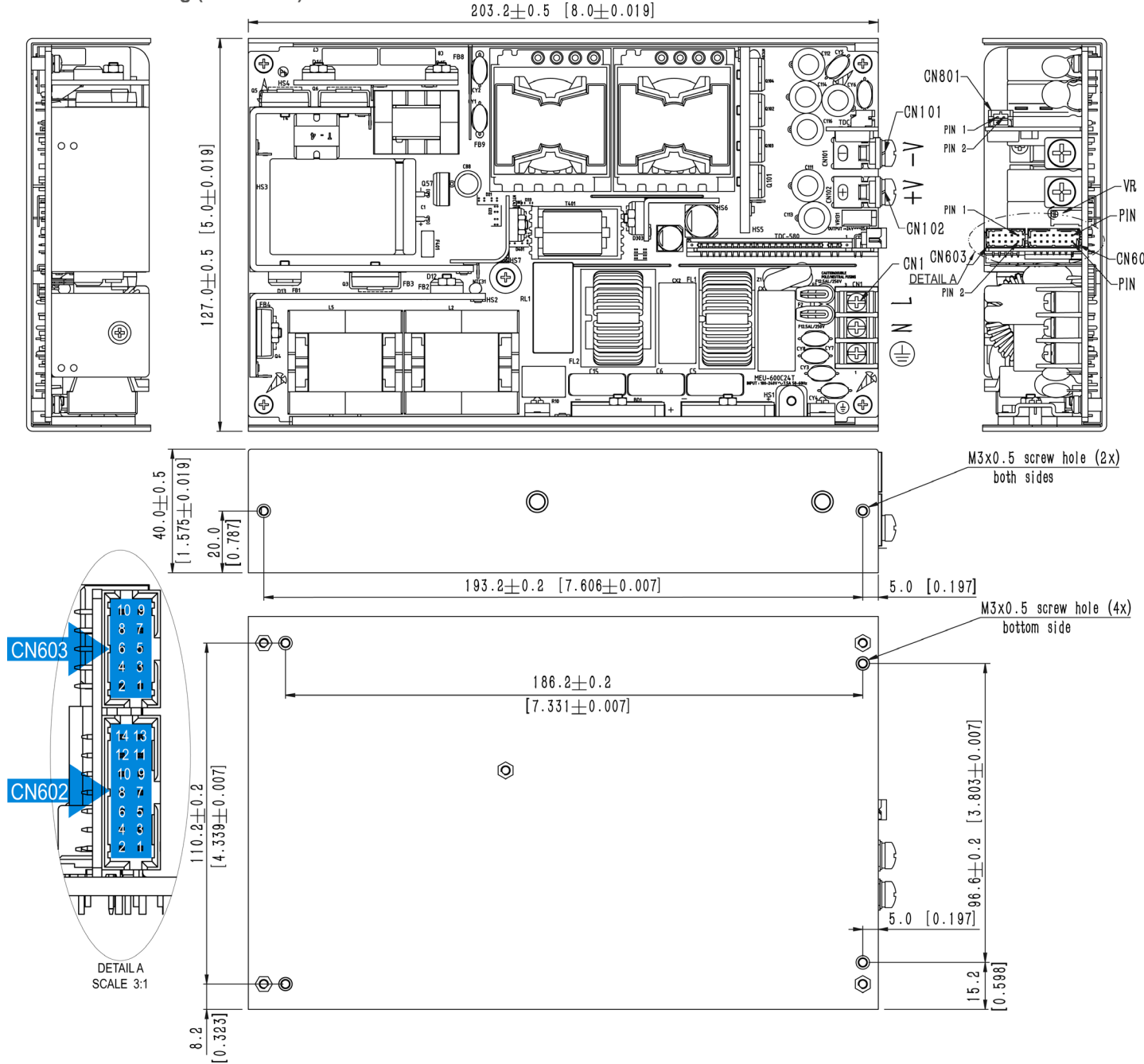

Notes:

1. Base plate mounting, M3 thread holes, maximum penetration 4.0 mm (0.16 inch) from outside face of chassis, maximum torque 6.3 kgf.cm (5.46 inch.lbs).
2. Side mounting, M3 thread holes, maximum penetration 4.0 mm (0.16 inch) from outside face of chassis, maximum torque 6.3 kgf.cm (5.46 inch.lbs).
3. CN101/CN102, M5 screw, maximum torque 20.0 kgf.cm (17.4 inch.lbs).
4. CN1, M3 screw, maximum torque 8.0 kgf.cm (7.0 inch.lbs).
5. VR: clockwise is to increase the output voltage, anti-clockwise is to reduce the output voltage.

Medical / Industrial AC-DC Power Supply

600 W Convection Cooling / MEU-600C series

Connector Definition and Pin Assignment

Input Connector CN1 (Anytek: YK4020323200G)	
Pin 1	Line
Pin 2	Neutral
Pin 3	Ground
Output Connector	
CN101	DC RTN
CN102	Vo
Control Connector CN603 (Molex:87833-1031) Mating With Molex: 51110-1060 or equivalent Terminal: 0503948052	
Pin 1	5V bus for I ² C
Pin 2	DC RTN of 5V bus for I ² C
Pin 3	Serial data signal (SDA)
Pin 4	Serial clock signal (SCL)
Pin 5	NC
Pin 6	NC
Pin 7	Address bit 0 (A0)
Pin 8	Address bit 1 (A1)
Pin 9	Address bit 2 (A2)
Pin 10	NC
Control Connector CN602 (Molex:87833-1420) Mating With Molex: 51110-1451 or equivalent Terminal: 0503948052	
Pin 1	Remote On_Off/Inhibit +
Pin 2	Remote On_Off/Inhibit -
Pin 3	Power Good-
Pin 4	Power Good+
Pin 5	NC
Pin 6	NC
Pin 7	5V Standby Output +
Pin 8	5V Standby Output +
Pin 9	DC RTN
Pin 10	DC RTN
Pin 11	Remote Sense +
Pin 12	Remote Sense -
Pin 13	Current Share
Pin 14	DC RTN
CN801(JST: S2B-PH-SM4-TB) Mating With JST: PHR-2 Terminal: SPH-002T-P0.5S	
Pin 1	DC RTN
Pin 2	12V for Fan

Medical / Industrial AC-DC Power Supply

600 W Convection Cooling / MEU-600C series

Functions

Start-up Time

The time required for the output voltage to reach 90% of its final steady state value, after the input voltage is applied.

Rise Time

The time required for the output voltage to change from 10% to 90% of its final steady state value.

Hold-up Time

Time between the collapse of the AC input voltage, and the output falling to 90% of its steady state value.

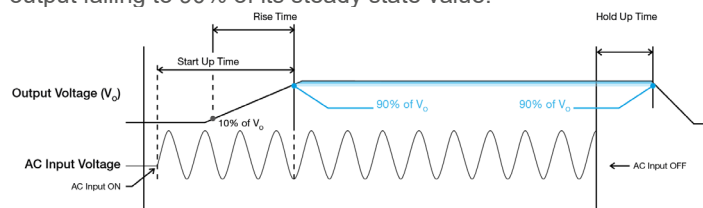

Figure 4. Time Sequence

Dynamic Response (Main Output)

The power supply output voltage will remain within $\pm 5\%$ of its steady state value, when subjected to a dynamic load 50 to 100% of its rated current.

■ 50 to 100% Load

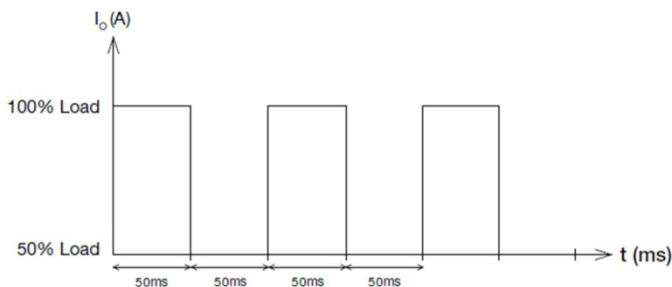

Figure 5. Dynamic Load

Inrush Current

Inrush current is the input current that occurs when the input voltage is first applied. For AC input voltages, the maximum peak value of inrush current will occur during the first half cycle of the applied AC voltage. This peak value decreases exponentially during subsequent cycles of AC voltage.

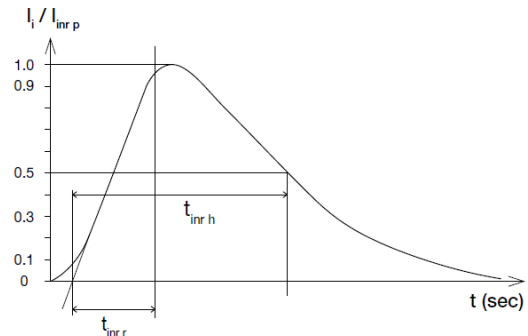

Figure 6. Inrush Current

Overvoltage Protection

The power supply's overvoltage circuit will be activated when its internal feedback circuit fails. The output voltage shall not exceed its specifications defined on Page 6 under "Protections". Power supply will latch off, and require removal/re-application of input AC voltage in order to restart.

Overload & Over current Protections

The power supply's Overload (OLP) and Over current (OCP) Protections will be activated before output current under 160% of I_o (Max load). Upon such occurrence, V_o will start to drop. Once the power supply has reached its maximum power limit, the protection will be activated and the power supply will go into "Hiccup mode" (Auto-Recovery). The power supply will recover once the fault condition causing the OLP and OCP is removed and I_o is back within the specified limit.

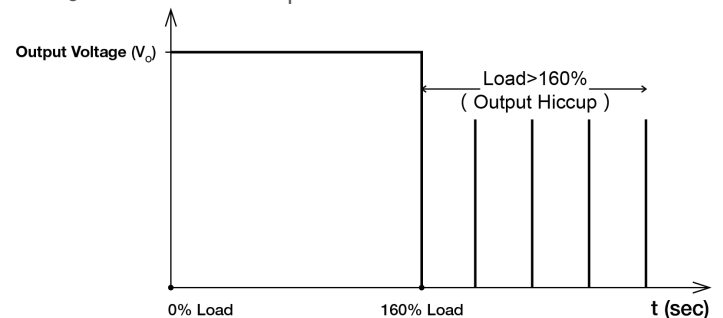

Figure 7. Hiccup at OLP/OCP

Additionally, if the load is $>100\%$; but $<160\%$ for a prolonged period of time (depending on the load), the Over Temperature Protection (OTP) may be activated due to high temperature on critical components. The power supply will then go into latch mode.

Medical / Industrial AC-DC Power Supply

600 W Convection Cooling / MEU-600C series

Short Circuit Protection

The power supply's output OLP/OCP function also provides protection against short circuits. When a short circuit is applied, the output current will operate in "Hiccup mode", as shown in the illustration in the OLP/OCP section on this page. The power supply will return to normal operation after the short circuit is removed.

Over Temperature Protection

As mentioned above, the power supply also has Over Temperature Protection (OTP). This is activated when the overload condition persists for an extended duration and the output current is below the overload trigger point but >100% load. In the event of a higher operating temperature condition at 100% load, the power supply will run into OTP when the surrounding air temperature is higher than the operating temperature. When activated, the output voltage will go into latch mode until the input voltage is removed; then, reapplied, and the surrounding air temperature drops to its normal operating temperature.

Power Good

Power Good+/- pin is an isolated open collector transistor (80 V/50 mA rating). A resistor (suggested value 10 Kohm, 1/8 W) can be added between Power Good- pin and DC RTN, Power Good+ pin can be connected to 5 V standby (or, other available pull-up voltage that is no greater than the transistor rating). Value of resistor may have to be adjusted, depending on voltage used, and other end-use conditions of the Power Good+ pin connection to the product. When AC input is on, Power Good Signal (Shown in below figure) generated will be high. When AC input is off, Power Good Signal generated will be low. There will be a minimum of 5 milliseconds between the time the Power Good Signal goes to low level, and the time when the output reaches 90% of its rated value.

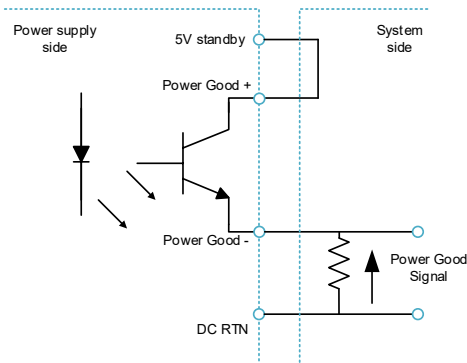

Figure 8. Power Good Connection

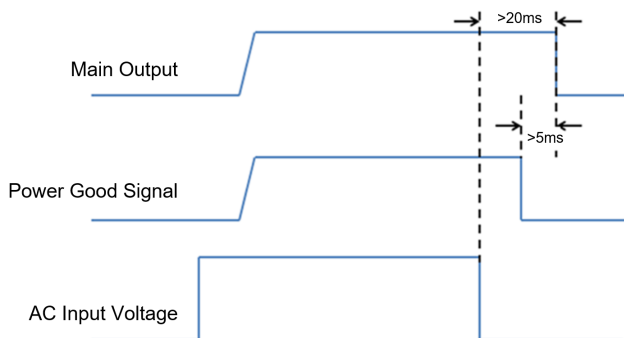

Figure 9. Power Good Time Sequence

Remote On_Off/Inhibit

Remote ON_OFF/INHIBIT uses an isolated diode located within the power supply. This signal can be used to enable or disable only the main output. When the main output is disabled, the +5 V Standby output will continue to operate. System can use a switch to conduct through this diode (suggested pull up resistor to 5 V standby with 1 Kohm resistor) to disable the main out. The signal can be floated (no connection to the signal), in order to enable the main output.

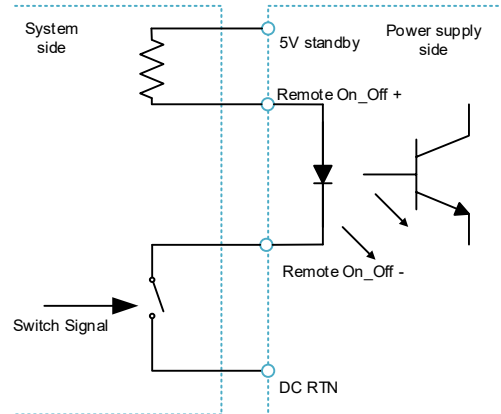

Figure 10. Remote On_Off Connection

Remote Sense

Remote sense feature can be used to compensate for the extra voltage drop on output wires that are connected from the main output terminals, to the load. With wires connected from the remote sense pins, at the same locations as the wires from the main output, the remote sense function can compensate up to 500mV voltage drop. The power supply will not be damaged if the remote sense pins are shorted, or if a reverse/inverted polarity connection is made to the load.

Voltage Adjustment

The power supply provides a potentiometer for user to adjust the output voltage. The output voltage is designed to be able to adjust up to $\pm 10\%$ of rated voltage, when the output is adjusted below nominal value, the maximum output current is the same as the nominal output, when the output is adjusted above nominal value, the output power cannot exceed the nominal maximum power (the maximum output current will be reduced accordingly).

PMBus

The power supply can communicate with the host product, using PMBus version 1.3 protocols. Multiple functions can be realized, such as monitoring the power supply operation status, and editing the power supply operating set-points. See user instruction for detailed control information.

Current Sharing

The power supply supports current sharing. Parallel the outputs as well as the current sharing bus to enable this feature.

Medical / Industrial AC-DC Power Supply

600 W Convection Cooling / MEU-600C series

Certificate



Delta has been certified as meeting the requirement of ISO 13485: 2003 and EN ISO 13485:2012 for the design and manufacture of switching power supply and adaptor for medical device.



In addition to a UL Total Certification Program (TCP) approved client laboratory for IEC 62368-1. Delta also has participated UL Client Test Data Program (CDTP) for IEC 60601

Attention

Delta provides all information in the datasheets on an "AS IS" basis and does not offer any kind of warranty through the information for using the product. In the event of any discrepancy between the information in the catalog and datasheets, the datasheets shall prevail (please refer to www.DeltaPSU.com for the latest datasheets information). Delta shall have no liability of indemnification for any claim or action arising from any error for the provided information in the datasheets. Customer shall take its responsibility for evaluation of using the product before placing an order with Delta.

Delta reserves the right to make changes to the information described in the datasheets without notice.

Manufacturer and Authorized Representatives Information

Manufacturer

Thailand

Delta Electronics (Thailand) PCL.
909 Pattana 1 Rd., Muang, Samutprakarn, 10280 Thailand

Taiwan

Delta Electronics, Inc.
3 Tungyuan Road, Chungli Industrial Zone, Taoyuan County
32063, Taiwan

Authorized Representatives

The Netherlands

Delta Greentech (Netherlands) B.V.
Zandsteen 15, 2132 MZ Hoofddorp, The Netherlands

United Kingdom

Delta Electronics Europe Limited
1 Redwood Court, Peel Park Campus,
East Kilbride, Glasgow, G74 5PF, United Kingdom