



BMR 350

860-1200 W digital quarter brick DC/DC IBC

The BMR350 is the next generation of high-power digital DC/DC converter. The impressive performance of this converter includes an efficiency of 97.8% at 54V_{in} and half load.

The BMR350 is a non-isolated quarter brick, and has a low building height of only 12 mm. The converter delivers a fully regulated 12 V. The BMR350 delivers a continuous power level of 860 W and has a peak power capability of up to 1200 W for less than 1 second.

This converter is designed for through-hole mounting using wave solder or pin-in-paste production, and incorporates a novel design of baseplate, which optimizes thermal performance while minimizing height.



Key features

- High efficiency with 97.8%
- Non-isolated
- 12 V fully regulated
- Event data recorder (black-box)
- Active current sharing
- Screwed baseplate
- Monotonic start-up
- Output over voltage protection
- Over temperature protection
- Output short-circuit protection
- Remote control
- PMBus configuration

Soldering methods

- Reflow soldering Pin-in-paste
- Wave soldering
- Manual soldering

Key electrical information

Parameter	Values
Input range	40-60 V
Output voltage	12 V
Output current	100 A
Output power	860 W
Peak power	1200 W

Mechanical

58.4 x 36.8 x 12 mm / 2.30 x 1.45 x 0.47 in

Application areas

- Datacom applications

Product options

The table below describes the different product options.

Example: BMR350 2 1 00 /031						H	Definitions
Product family	BMR350						
Pin length options		2					0 = 5.33 mm / 0.21 in 2 = 3.69 mm / 0.15 in 3 = 4.57 mm / 0.18 in 4 = 2.79 mm / 0.11 in
Baseplate / HS option			1				1 = base plate
Other hardware options				00			00 = 7-pin digital header
Configuration code					/031		/031=12 V _{out} Current share config. for 40-60 V _{in}
Packaging options						H	E = soft tray, dry pack (PIP reflow soldering) H = hard tray, dry pack (PIP reflow soldering) blank = foam tray (no dry pack, wave soldering)

For more information, please refer to Part 3 [Mechanical information](#).

If you do not find the variant you are looking for, please contact us at [Flex Power Modules](#).

Order number examples

Part number	V _{in}	Outputs	Configuration
BMR350 2100/031H	40-60 V	12V / 72A/ 860 W	3.69 mm pins / 7-pin digital header / base plate / current share / dry pack, hard tray

Part 1: Electrical specifications

Absolute maximum ratings

Stress in excess of our defined *absolute maximum ratings* may cause permanent damage to the converter. Absolute maximum ratings, also referred to as *non-destructive limits*, are normally tested with one parameter at a time exceeding the limits in the electrical specification.

Characteristics	min	typ	max	Unit
Operating temperature (T_{P1})	-40		+125	°C
Storage temperature	-55		+125	°C
Input voltage (V_{in})	-0.5		+65	V
Input voltage transient (100 ms)			+80	V
Isolation voltage (input to output)			0	V
Isolation voltage (baseplate to output)			0	V
Remote control pin voltage	-0.3		5	V

Reliability

Failure rate (λ) and mean time between failures ($MTBF = 1/\lambda$) are calculated based on *Telcordia SR-332 Issue 4: Method 1, Case 3, (80% of I_{out_TDP} , $T_{P1}=40^{\circ}C$, Airflow=200 LFM)*.

	Mean	90% confidence level	Unit
Steady-state failure rate (λ)	132	161	nfailures/h
Standard deviation (σ)	22,4		nfailures/h
MTBF	7,57	6,22	MHr

Typical application diagram

Capacitor values are defined in the Electrical Specification tables. The EMI filter is defined in the [EMC Part 2](#).

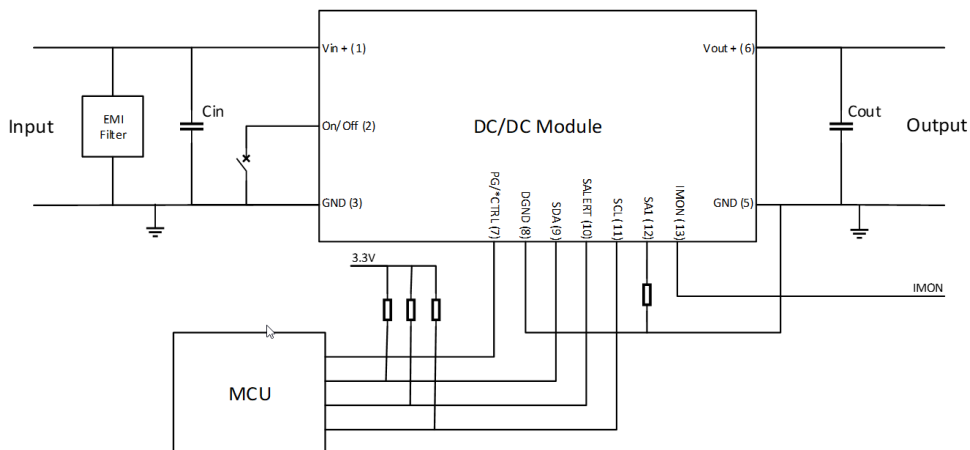

Part 1: Electrical specifications

Electrical specifications for BMR350 X100/031**12.24V, 72A (100A) ≤ 860W (1200W)**

Min and Max values are valid for: $T_{P1} = -30$ to $+90^{\circ}\text{C}$, $V_{in} = 40\text{V}$ to 60V , unless otherwise specified under conditions. Typical values given at: $T_{P1} = +25^{\circ}\text{C}$, $V_{in} = 54\text{V}$, max P_{out_TDP} , unless otherwise specified under conditions, see Note 1.

Additional external $C_{in} = 470\ \mu\text{F}$, $C_{out} = 1\ \text{mF}$

Characteristic	conditions	minimum	typical	maximum	unit
Key features					
Efficiency (η)	50% of P_{out_TDP}		97.8		%
	100% of P_{out_TDP}		97.6		%
	50% of P_{out_TDP} $V_{in} = 48\ \text{V}$		98.1		%
	100% of P_{out_TDP} $V_{in} = 48\ \text{V}$		97.8		%
P_{out_TDP} thermal design power (TDP)	See Note 1			860	W
P_{out_MAX} peak power ($t \leq 1\text{s}$)	See Note 1			1200	W
Power dissipation	100% of P_{out_TDP}		21.5	29	W
Switching frequency (f_s)	0-100 % of P_{out_TDP}		150		kHz
Recommend capacitive load		1000		20000	μF
Input characteristics					
Input voltage range (V_{in})		40		60	V
Input idling power	$P_{out} = 0\ \text{W}$		5.3		W
Input standby power	(turned off with RC)		650		mW
Input OVP			85		V
Internal input capacitance			90		μF
Recommended external input capacitance		220			μF

Note 1: Max. output current is rated at 100 A. Max power is $\leq 1200\ \text{W}$ and continuous power (thermal design power (TDP)) is $\leq 860\ \text{W}$ depending on thermal conditions.

Part 1: Electrical specifications

Electrical specifications for BMR350 X100/031**12.24V, 72A (100A) ≤ 860W (1200W)**

Min and Max values are valid for: $T_{P1} = -30$ to $+90^{\circ}\text{C}$, $V_{in} = 40\text{V}$ to 60V , unless otherwise specified under conditions. Typical values given at: $T_{P1} = +25^{\circ}\text{C}$, $V_{in} = 54\text{V}$, max P_{out_TDP} , unless otherwise specified under conditions, see Note 1.

Additional external $C_{in} = 470\ \mu\text{F}$, $C_{out} = 1\ \text{mF}$

Characteristic	conditions	minimum	typical	maximum	unit
Output characteristics					
Output voltage initial setting and accuracy	$P_{out} = 0\ \text{W}$	12.18	12.24	12.3	V
Output voltage tolerance band	0 – 100% of max P_{out_TDP} $V_{in} = 40\text{-}60\ \text{V}$	11.7		12.4	V
Output adjust range	0-100% of max P_{out_TDP}	8		13.2	V
Idling voltage	$P_{out} = 0\ \text{W}$, 48 V	12.1		12.4	V
Line regulation	$V_{in} = 40 - 60\ \text{V}$ 0 – 100% of max P_{out_TDP}		3	12	mV
Load regulation	0 - 100% of max P_{out_TDP}		94	145	mV
Output current (I_{out})	$V_{in} = 40 - 60\ \text{V}$	0		100	A
Load transient voltage deviation	Load step 25-75-25% of max P_{out_TDP} $di/dt = 1\ \text{A}/\mu\text{s}$. See Note 2		± 100	± 300	mV
Load transient recovery time			50	100	μs
Output ripple & noise	max P_{out_TDP} See Note 3		50	78	mV _{p-p}

Note 1: Max. output current is rated at 100 A. Max power is $\leq 1200\ \text{W}$ and continuous power (thermal design power (TDP)) is $\leq 860\ \text{W}$ depending on thermal conditions.

Note 2: C_{out} is 2x2.2mF

Note 3: See Technical Reference doc: Design considerations

Electrical specifications for BMR350 X100/031**12.24V, 72A (100A) ≤ 860W (1200W)**

Characteristic	conditions	minimum	typical	maximum	unit
On/off control					
Turn-off input voltage	Decreasing input voltage	34	35	36	V
Turn-on input voltage	Increasing input voltage	36	37	38	V
Ramp-up time (from 0–100% of V_{out})		7	10	13	ms
Start-up time (from V_{in} connection to 90% of V_{out})			40		ms
RC start-up time			26		ms
Logic high: trigger level			1.4		V
Logic low: trigger level			1.3		V
Logic low: response time		0.1	0.2	0.3	ms
Sink current		0.4			mA
Protection features					
Current limit threshold (OCP)	$T_{P1} < \max T_{P1}$	102	110	125	A
Output current limit (OCP) response time and type	hiccup		25		μ s
Output overvoltage protection (OVP)			15.6		V
Output overvoltage protection (OVP) response time and type	Disabled until fault cleared		70		μ s
Over temperature protection (OTP)	See note 1		120		°C
Over temperature protection (OTP) type	Disabled, Resume when OK				ms

Note 1: Please attach thermocouple on NTC resistor to test OTP function, the hot spot (P1) temperature is just for reference.

Electrical specifications for BMR350 X100/031**12.24V, 72A (100A) ≤ 860W (1200W)**

In the table below all PMBus are written in capital letters.

$T_{P1} = -30$ to $+90^{\circ}\text{C}$, $V_{in} = 40\text{V}$ to 60V , unless otherwise specified under conditions.

Typical values given at: $T_{P1} = +25^{\circ}\text{C}$, $V_{in} = 54\text{V}$, max P_{out_TDP} , unless otherwise specified under conditions

Command	Conditions	minimum	typical	maximum	Unit
Monitoring accuracy					
Input voltage READ_VIN			±125		mV
Output voltage READ_VOUT			±40		mV
Output current READ_IOUT	$T_{P1} = 25^{\circ}\text{C}$, $V_O = 12\text{V}$		±0.5		A
	$T_{P1} = -20-120^{\circ}\text{C}$, $V_O = 12\text{V}$		±2.5		A
Duty cycle READ_DUTY_CYCLE	No tolerance, Read value is the actual value applied by PWM controller				
Temperature READ_TEMPERATURE_1	Temperature sensor, $-20-120^{\circ}\text{C}$		±5		$^{\circ}\text{C}$

For more detailed information please refer to Technical Reference Document: PMBus commands.

This product is supported by the [Flex Power Designer tool](#).

Electrical graphs for BMR350 X100/031

12V, 72A (100A) ≤860W (1200W)

Efficiency

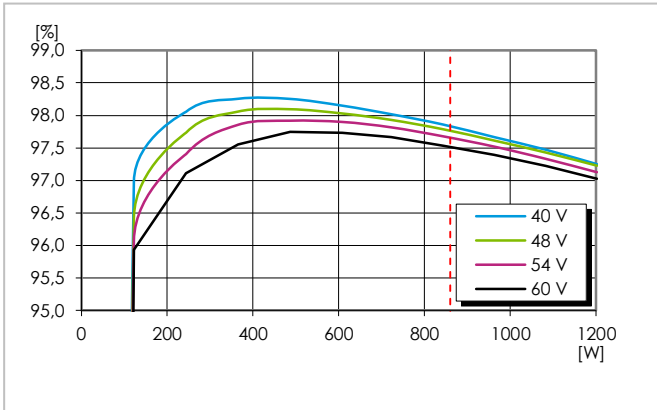

Efficiency vs. output power and input voltage at $T_{PI} = +25^{\circ}$
Above 860W only peak $t \leq 1s$

Power dissipation

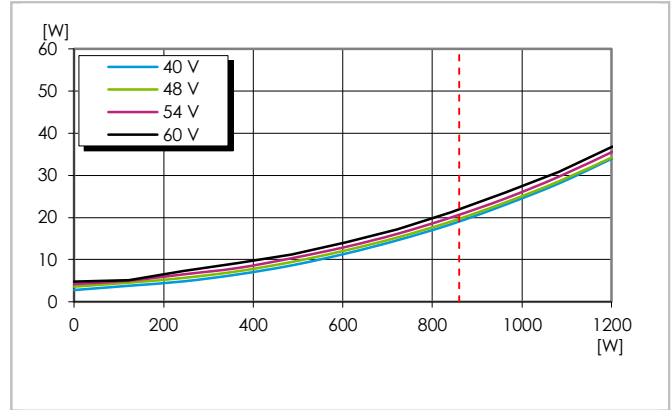

Dissipated power vs. load power at $T_{PI} = +25^{\circ}$
Above 860W only peak $t \leq 1s$

Line regulation

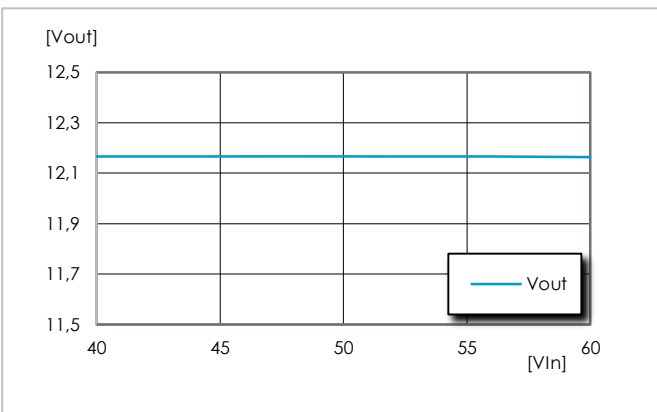

Output voltage vs. input voltage at $T_{PI} = +90^{\circ}$ C, 100% of max
Pout_TDP

Available power

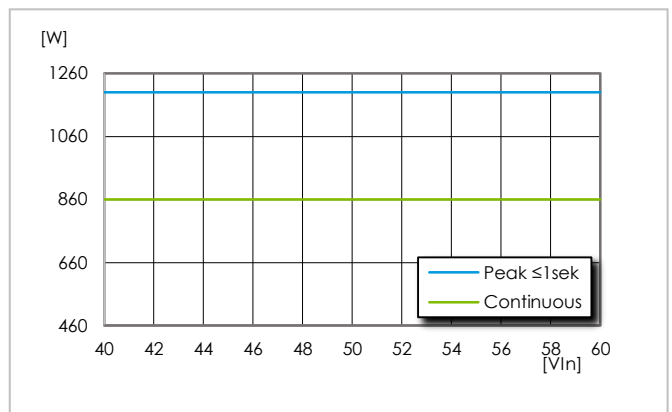

Available output power vs. input voltage, $T_{PI} = +90^{\circ}$ C

Power loss at max temperature

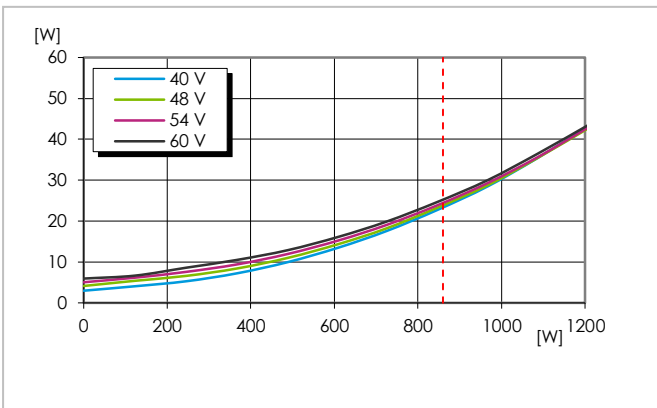

Dissipated power vs. output power and input voltage at $T_{PI} = +90^{\circ}$ C
Above 860W only peak $t \leq 1s$

Output voltage adjust range

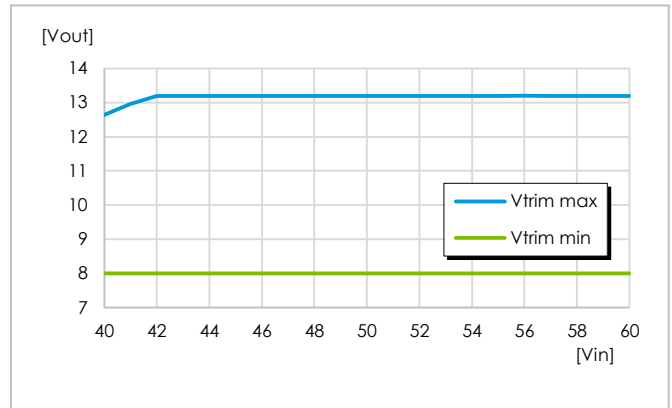

Max and min V_{out} trim vs V_{in}

Part 2: EMC

EMC specifications

Conducted EMI measured according to EN55022 / EN55032, CISPR 22 / CISPR 32 and FCC part 15J (see test set-up below). The fundamental switching frequency is 150kHz for BMR350. The EMI characteristics below is measured at $V_{in} = 54\text{ V}$ and max I_{out} .

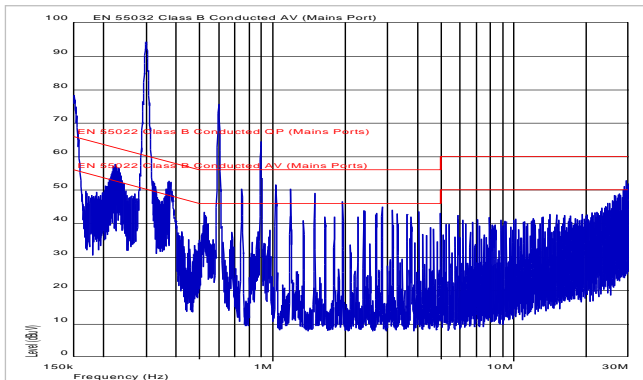

EMI without filter. EN55032 test method and limits are the same as EN55022. 220 μF 100V input capacitor and 1000 μF 16 V OS-CON output capacitor used

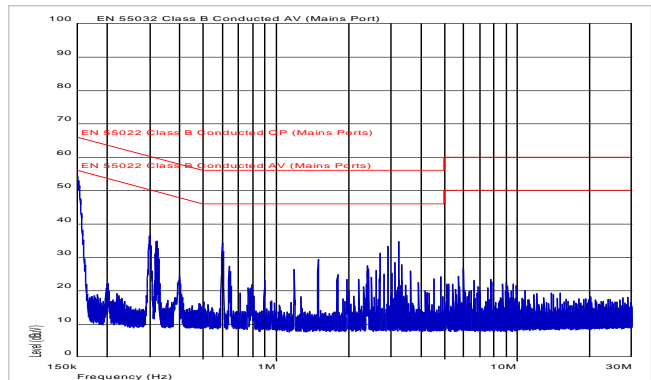

EMI with filter, EN55032 test methods and limits are the same as EN55022.

Optional external filter for Class B

Suggested external input filter in order to meet Class B in EN 55022 / EN 55032, CISPR 22 / CISPR 32 and FCC part 15J.

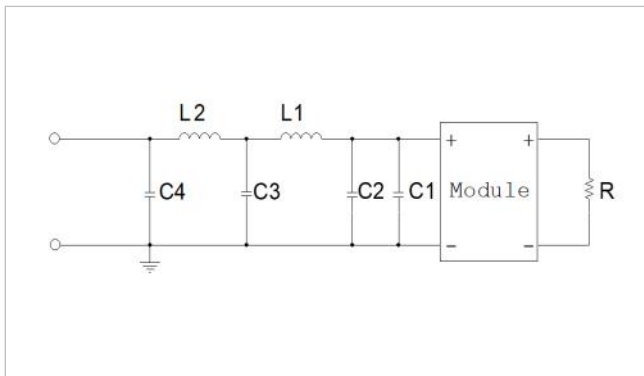

Filter components:
 C1 = 220 μF (e-lyt)
 C2 = 2 x 2.2 μF
 C3, C4 = 10 μF
 L1, L2 = 4.7 μH

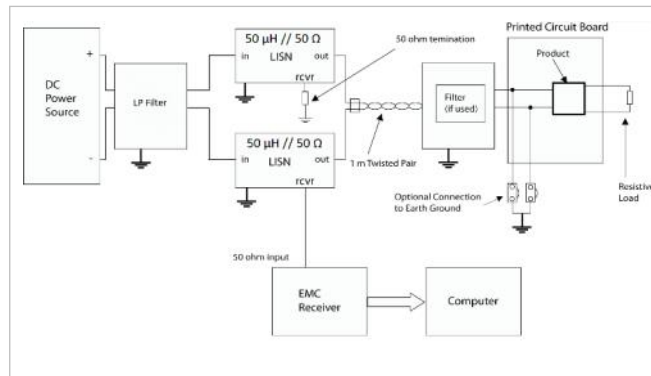

Test set-up

Layout recommendations

The radiated EMI performance of the product will depend on the PWB layout and ground layer design. It is also important to consider the stand-off of the product. If a ground layer is used, it should be connected to the output of the product and the equipment ground or chassis.

A ground layer will increase the stray capacitance in the PWB and improve the high frequency EMC performance.

Part 3: Mechanical information

BMR350 X1XX/XXX: hole mounted, baseplate version

The mechanical information is based on a module which is hole mounted and has a baseplate.

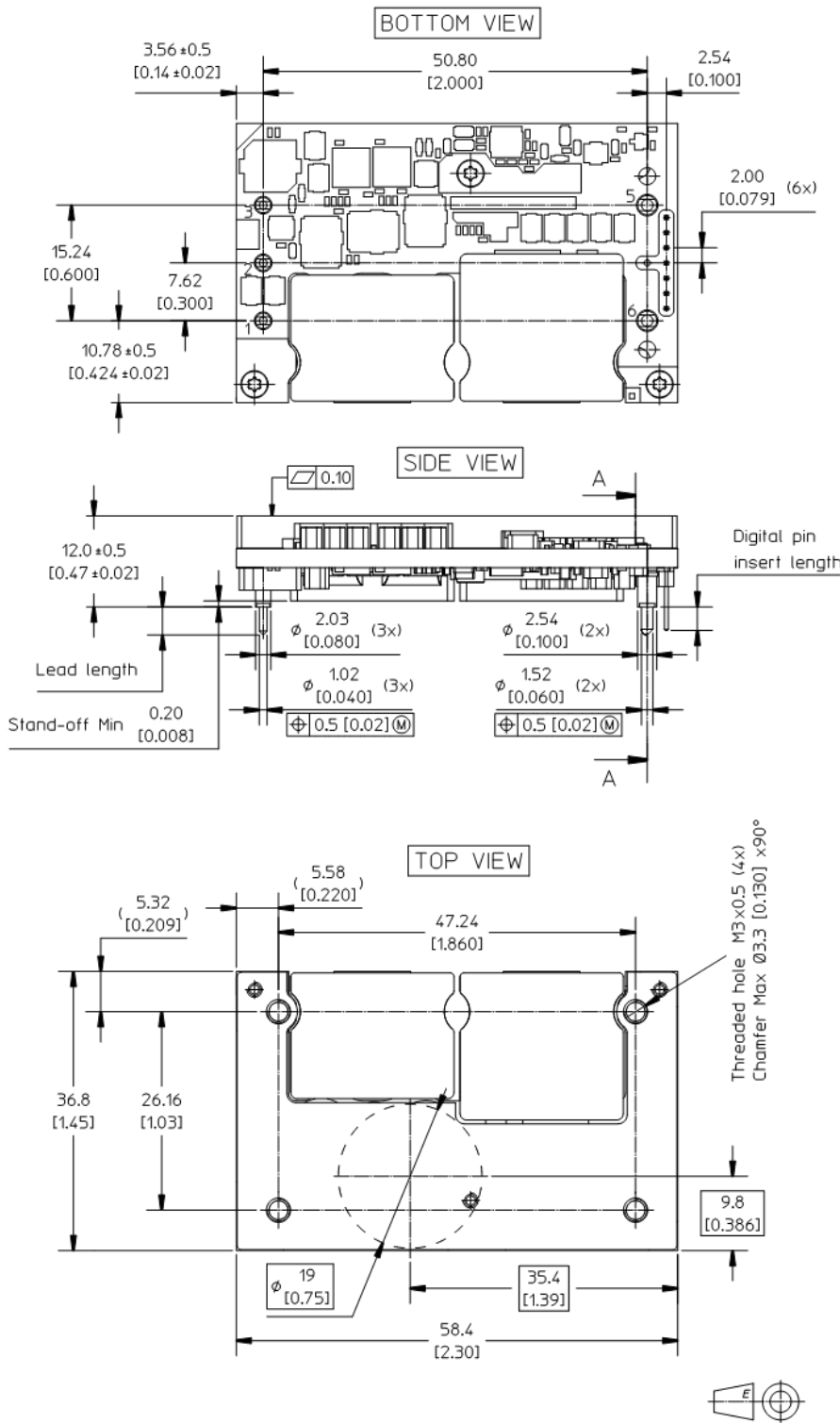

	Lead length	Digital pin insert length
Standard	5.33 [0.210]	4.10 [0.161]
LA	3.69 [0.145]	3.10 [0.122]
LB	4.57 [0.180]	4.10 [0.161]
LC	2.79 [0.110]	2.10 [0.083]

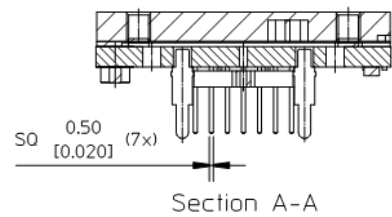

NOTES:
BASEPLATE INTERFACE
 Material: Aluminium
 For screw attachment apply mounting torque of max 0.48 Nm [4.3 lbf in.].
 M3 screw must not protrude more than 3.0 mm [0.118 in.] into the baseplate.

WEIGHT
 Typical: 83 g

All dimensions are in mm and [inch].
 Tolerances unless specified:
 x.x mm ±0.50 mm, [x.xx in. ±0.02 in.]
 x.xx mm ±0.25 mm, [x.xxx in. ±0.010 in.]

3D MODELS
 3D .stp models are available on request.

All component placements, whether shown as physical components or symbolical outline, are for reference only and are subject to change throughout the product's life cycle unless explicitly described and dimensioned in this drawing.

Footprint and pin positions

OUTLINE AND RECOMMENDED FOOTPRINT - TOP VIEW

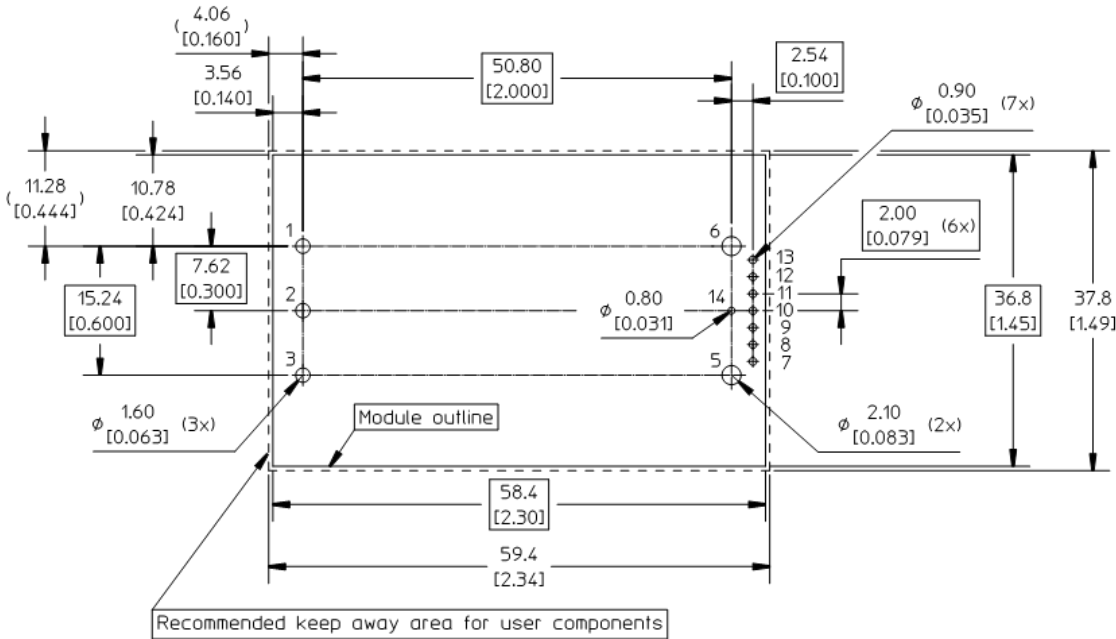

CONNECTIONS - BOTTOM VIEW

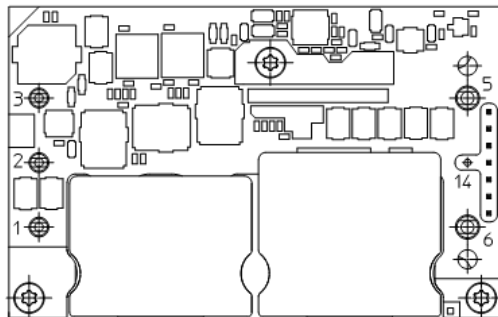

PIN SPECIFICATIONS:

Pin 1-3, 5-6 Material: Copper alloy
Plating: Min Au 0.1 µm over Ni 1-3 µm

Pin 7-13 Material: Brass
Plating: Min Au 0.1 µm over Ni 1-3 µm

Pin 14 Not mounted (Option)

Pin	Designation	Function 7 pin
1	+In	Positive Input
2	RC	Remote Control
3	-In	Negative Input
5	-Out	Negative Output
6	+Out	Positive Output

Pin	Designation	Function 7 pin
7	PG	Power Good
8	DGND	PMBus ground
9	SDA	PMBus Data
10	SALERT	PMBus alert signal
11	SCL	PMBus Clock
12	SA1	PMBus Address 1
13	IMON	Current Share

Part 4: Thermal considerations

Thermal considerations

The products are designed to operate in different thermal environments and sufficient cooling must be provided to ensure reliable operation.

General

For products mounted on a PWB without a heatsink attached, cooling is achieved mainly by conduction, from the pins to the host board, and convection, which is dependent on the airflow across the product. Increased airflow enhances the cooling of the product. The wind speed and temperature are measured in a point upstream the device. The *output current derating graphs* found later in this section for each model provide the available output current vs. ambient air temperature and air velocity at $V_{in} = 54\text{ V}$.

For products using any form of heatsink structure a top spacing board and side airflow guides are used to ensure airflow hitting the module and not diverted away.

Distance between the tested device and the top space board and the side airflow guides are $6.35\text{ mm} \pm 1\text{ mm}$.

The product is tested on a $185 \times 185\text{ mm}$, $105\text{ }\mu\text{m}$ (3 oz), 6-layer test board mounted vertically in a wind tunnel.

For products with baseplate used in a sealed box/cold wall application, cooling is achieved mainly by conduction through the cold wall. The product is tested in a sealed box test set up with ambient temperatures 85°C . See [Design Note 028](#) for further details.

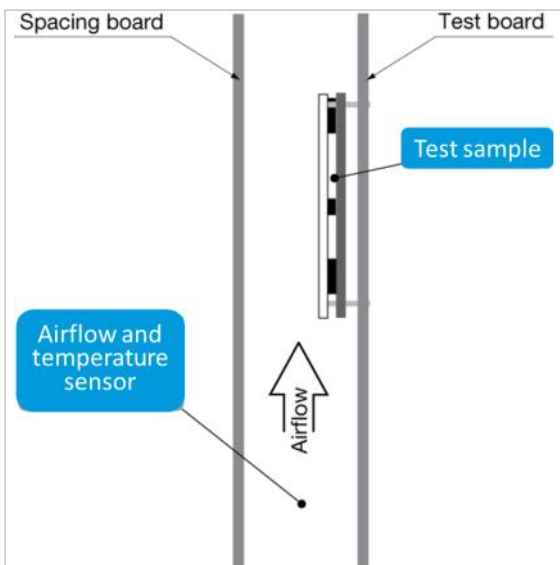

Picture: general test set-up

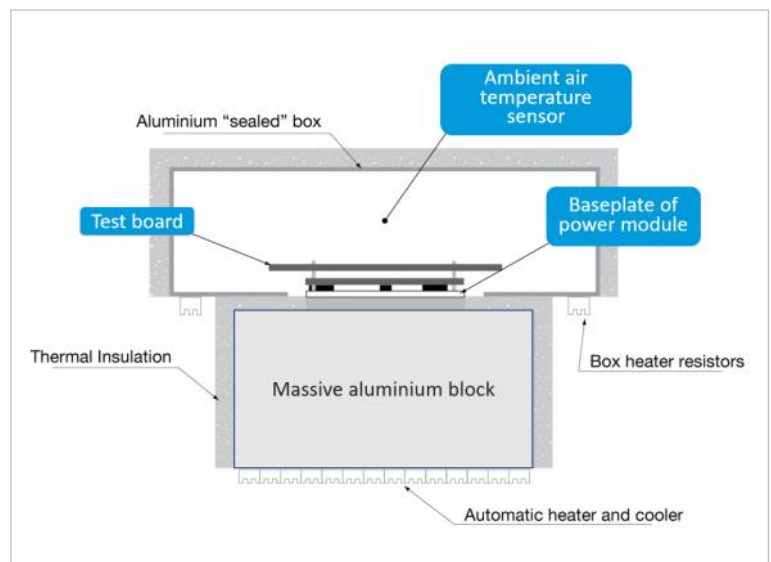

Picture: cold wall test set-up

Part 4: Thermal considerations

Definition of product operating temperature

Proper thermal conditions can be verified by measuring the temperature at position P1 as shown below. The temperature at this position (T_{P1}) should not exceed the maximum temperatures in the table below. The number of measurement points may vary with different thermal design and topology. Temperatures above maximum T_{P1} , measured at the reference point P1 are not allowed and may cause permanent damage.

Position	Description	Max. Temp.
P1	PWB reference point	$T_{P1} = 125^{\circ}\text{C}$

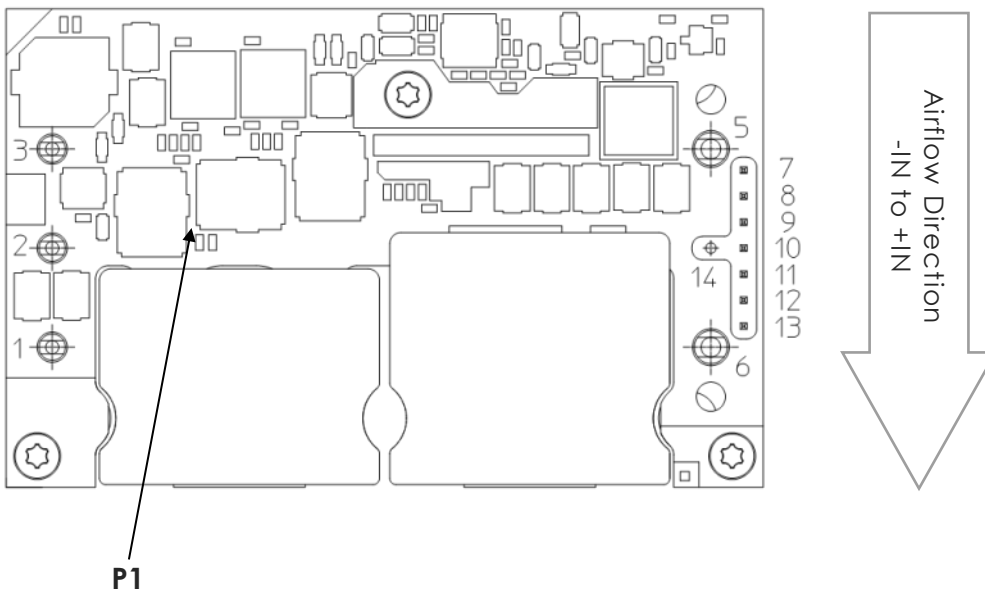
Bottom view

Thermal graphs

Output power derating - 1.0 inch heatsink

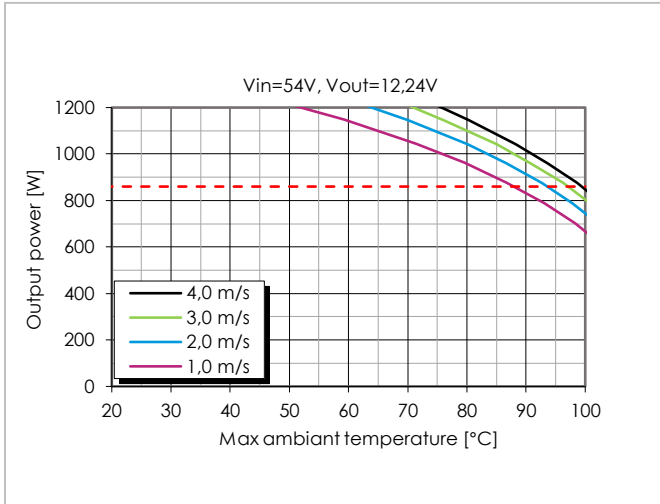

Available output power vs. ambient air temperature and airflow. Above 860W only peak $t \leq 1s$. Airflow Direction -IN to +IN.

Output power derating - 0.5 inch heatsink

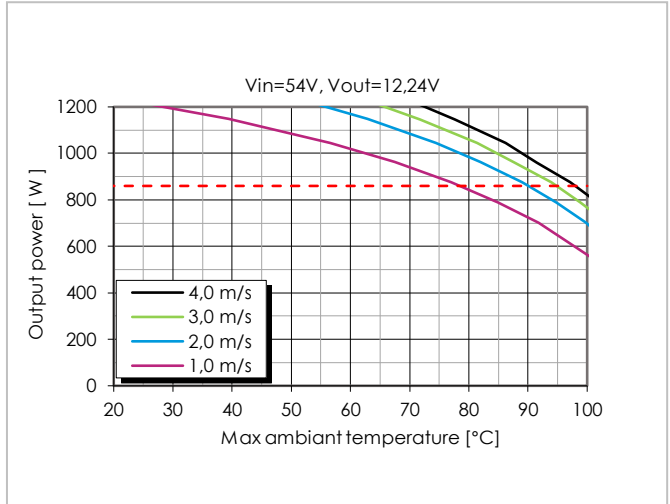

Available output power vs. ambient air temperature and airflow. Above 860W only peak $t \leq 1s$. Airflow Direction -IN to +IN.

Maximum Output Power

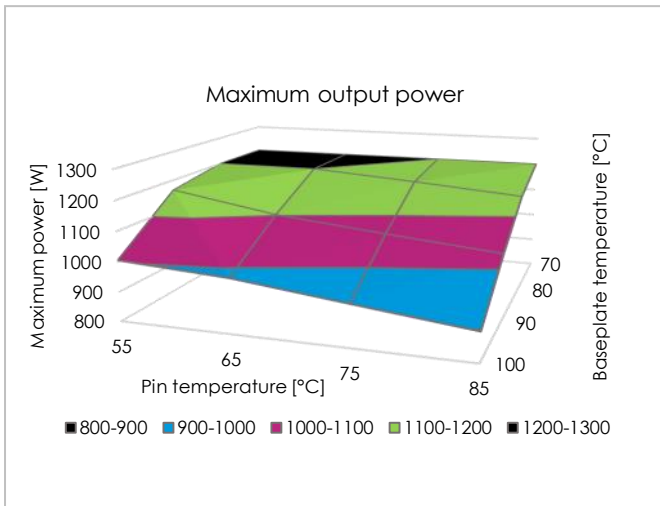

Maximum allowed thermal power (restriction by POMAX might occur). Above 860W only peak $t \leq 1s$.

Maximum Allowed Power Loss

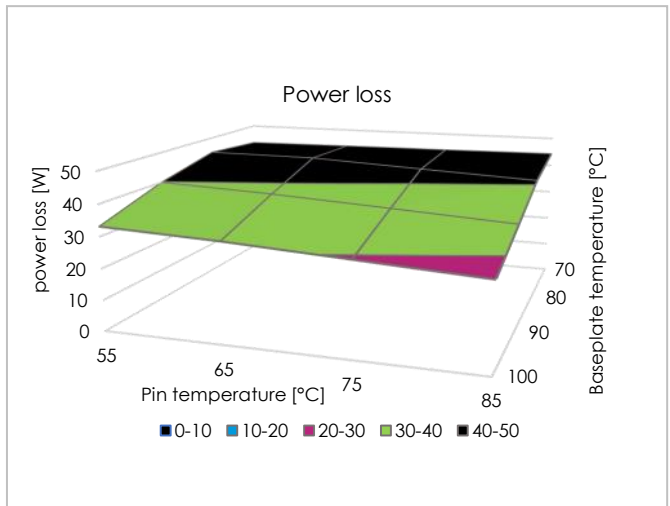

Available output power vs. pin and baseplate temperature See Thermal Consideration section. Above 860W only peak $t \leq 1s$.

For more information, please refer to our [thermal models](#) on the website.

Part 5: Packaging

Packaging information

H option: Select for PIP reflow solder and pick & place - dry packed

Material	Antistatic Polyphenylene Ester (PPE)
Surface resistance	$\geq 1 \times 10^4$ to $< 1 \times 10^{11}$ ohms
Bakability	Tray can be baked at max. 125 °C for 24 h. Please remove the fitments before baking.
Tray capacity	14 converters/tray
Box capacity	42 products (3 full trays/ box)
Tray weight	214 g empty tray, 1376 g full tray open deck baseplate.

JEDEC standard tray.
All dimensions in mm

Tolerances: X.x ± 0.26 [0.01], X.xx ± 0.13 [0.005]

Note: Pick up positions refer to center of pocket.

See [mechanical drawing](#) for exact location on product.

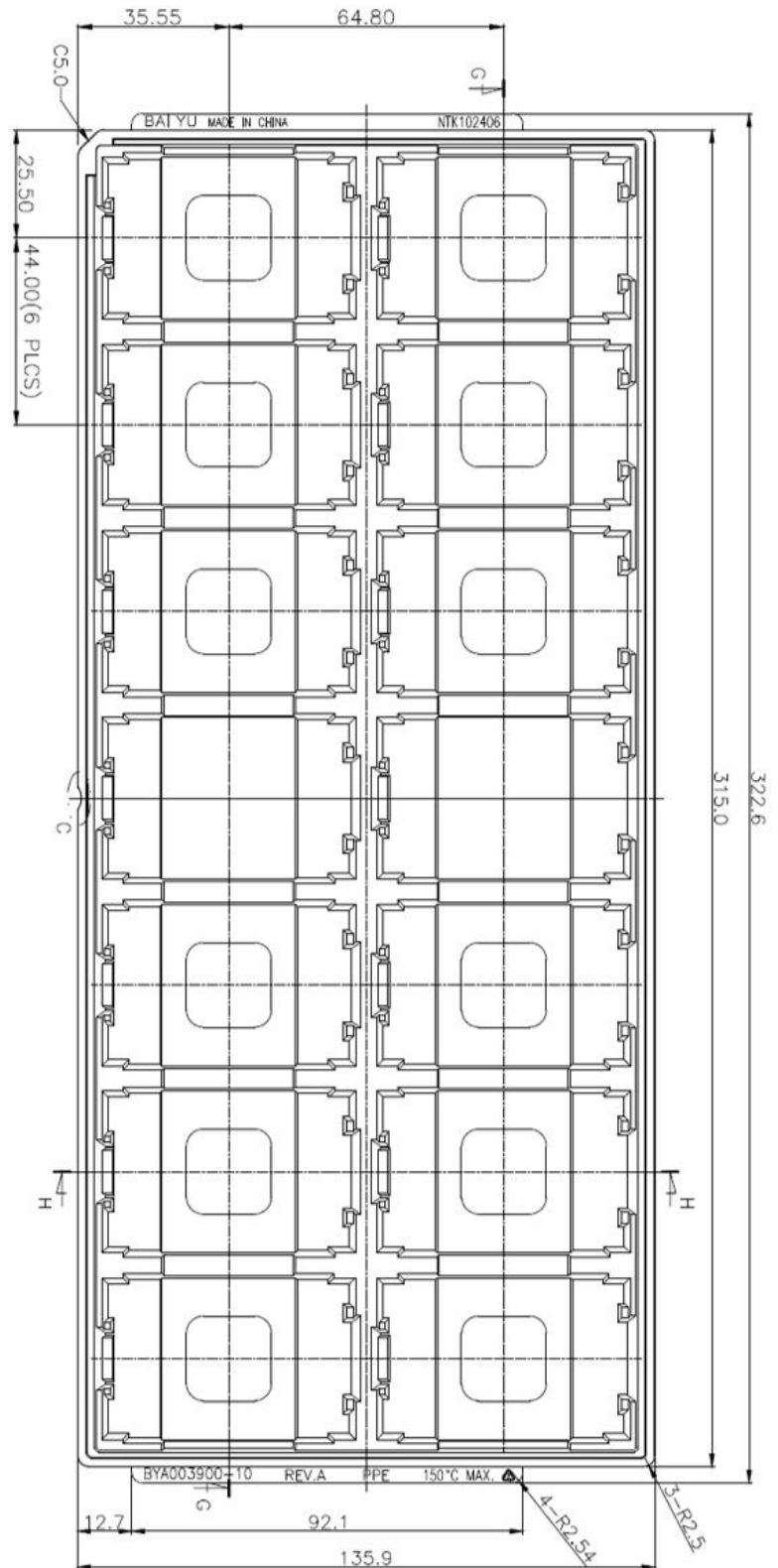

Packaging information

Blank option: Select for wave or hand soldering, NOT dry packed

Material	Antistatic Polyethylene (PE) foam
Surface resistance	$\geq 1 \times 10^4$ to $< 1 \times 10^{11}$ ohms
Bakability	Tray cannot be baked
Tray capacity	20 converters / tray
Box capacity	60 products (3 full trays/ box)
Weight	48 g empty tray, 1708 g full tray.

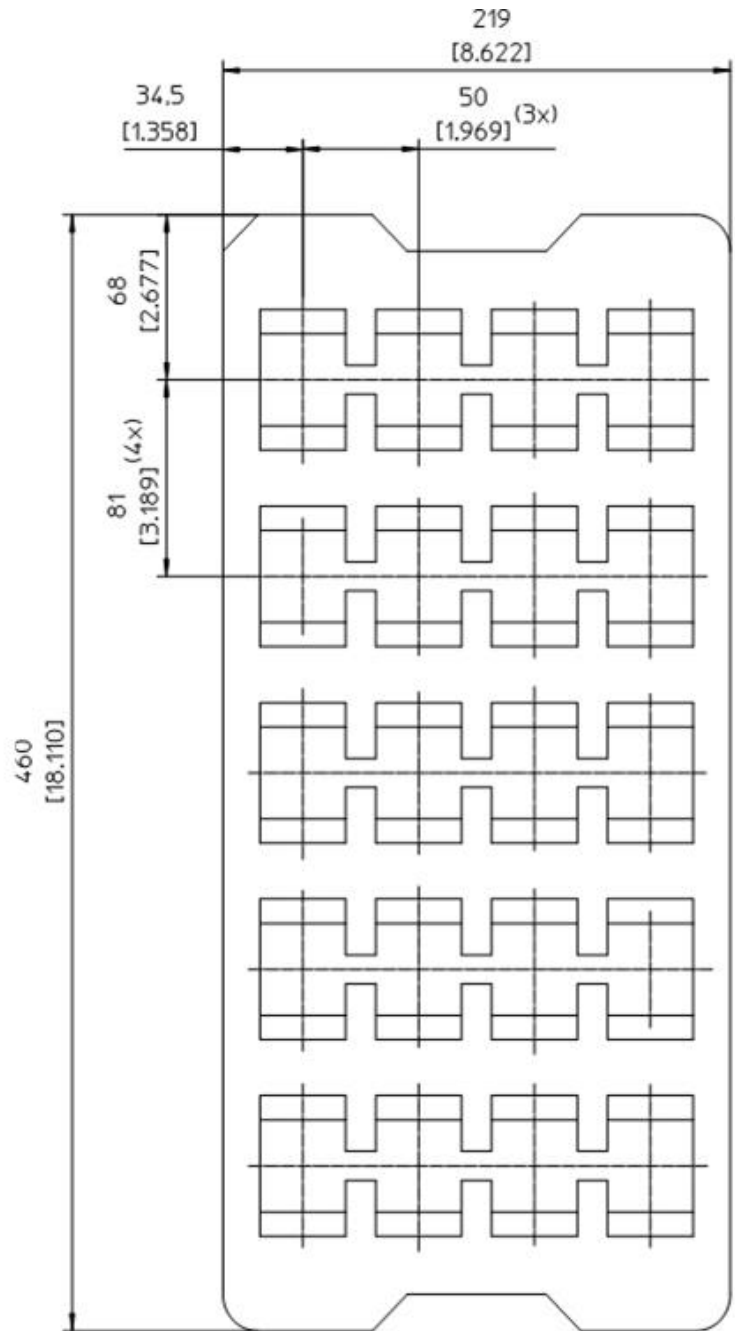

Example PE foam tray

Part 6: Revision history

Revision table

Revision number	revision change	date	revisor
Rev. A	New document	Mar 1st, 2022	Marshall Wang
Rev. B	Add baseplate flatness 0.1mm;	July 8th, 2022	Marshall Wang

© Flex Power Modules 2022

The information and specifications in this technical specification is believed to be correct at the time of publication. However, no liability is accepted for inaccuracies, printing errors or for any consequences thereof. Flex reserves the right to change the contents of this technical specification at any time without prior notice.

flex[®]

Flex Power Modules, a business line of Flex, is a leading manufacturer and solution provider of scalable DC/DC converter primarily serving the data processing, communications, industrial and transportation markets. Offering a wide range of both isolated and non-isolated solutions, its digitally-enabled DC/DC converters include PMBus compatibility supported by the powerful Flex Power Designer.

