

**PUC-D2BG series DC/DC Converters**  
Isolated 2W Unregulated Dual Output

28701-BMR808 Rev. A

March 2022

© Flex

### Key Features

- Industry standard SIP-7 package  
19.5 x 9.8 x 12.5 mm (0.77 x 0.385 x 0.49 in)
- High efficiency, typ. 81% at +15/-9 Vout full load
- 6200 Vdc input to output isolation
- Reinforced insulation - 250Vac rated working voltage
- Ultra low isolation capacitance, typically <6pF
- Meets safety requirements according to IEC/EN/UL62368-1
- Wide operating temperature from -40°C to 100°C
- No minimum load required
- Continuous output short-circuit protection
- MTBF 13 Mhrs

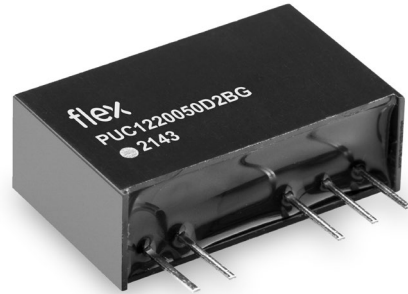

### General Characteristics

- 2 Watt output power
- Safety Compliance to EN 62368-1
- ISO 9001/14001 certified supplier
- 12 V, 15 V & 24 V inputs
- +15 V / -3 V; +15 V / -5 V; +18 V / -2.5 V; +18 V / -5 V;  
+20 V / -3.5 V; +20 V / -5 V; +15 V / -9 V; +17 V / -9 V;  
+18 V / -9 V & ±15 V outputs

#### Safety Approvals



#### Design for Environment



Meets requirements in high-temperature lead-free soldering processes.

### Contents

Ordering Information	2
General Information	2
Safety Specification	3
Absolute Maximum Ratings	5
Electrical Specification	
12-24 Vi / 2.5-20 Vo, 0.05-0.11 A / 2 W	PUC-D2BG Series..... 6
EMC Specification	12
Operating Information	13
Thermal Consideration	14
Connections	14
Mechanical Information	15
Soldering Information	16
Delivery Information	16
Product Qualification Specification	17

<b>PUC-D2BG series DC/DC Converters</b> Isolated 2W Unregulated Dual Output	28701-BMR808 Rev. A	March 2022
	© Flex	

**Ordering Information**

Product	Nominal Input	Output
PUC1215030D2BG	12 V	+15 V/+110 mA, -3 V/-100 mA
PUC1215050D2BG	12 V	+15 V/+100 mA, -5 V/-100 mA
PUC1218025D2BG	12 V	+18 V/+80 mA, -2.5 V/-80 mA
PUC1218050D2BG	12 V	+18 V/+90 mA, -5 V/-90 mA
PUC1220035D2BG	12 V	+20 V/+90 mA, -3.5 V/-80 mA
PUC1220050D2BG	12 V	+20 V/+80 mA, -5 V/-80 mA
PUC1215090D2BG	12 V	+15 V/+100 mA, -9 V/-60 mA
PUC1217090D2BG	12 V	+17 V/+90 mA, -9 V/-50 mA
PUC1218090D2BG	12 V	+18 V/+90 mA, -9 V/-50 mA
PUC1215150D2BG	12 V	±15 V/±67 mA
PUC1515030D2BG	15 V	+15 V/+110 mA, -3 V/-100 mA
PUC1515050D2BG	15 V	+15 V/+100 mA, -5 V/-100 mA
PUC1518025D2BG	15 V	+18 V/+80 mA, -2.5 V/-80 mA
PUC1518050D2BG	15 V	+18 V/+90 mA, -5 V/-90 mA
PUC1520035D2BG	15 V	+20 V/+90 mA, -3.5 V/-80 mA
PUC1520050D2BG	15 V	+20 V/+80 mA, -5 V/-80 mA
PUC1515090D2BG	15 V	+15 V/+100 mA, -9 V/-60 mA
PUC1517090D2BG	15 V	+17 V/+90 mA, -9 V/-50 mA
PUC1518090D2BG	15 V	+18 V/+90 mA, -9 V/-50 mA
PUC1515150D2BG	15 V	±15 V/±67 mA
PUC2415030D2BG	24 V	+15 V/+110 mA, -3 V/-100 mA
PUC2415050D2BG	24 V	+15 V/+100 mA, -5 V/-100 mA
PUC2418025D2BG	24 V	+18 V/+80 mA, -2.5 V/-80 mA
PUC2418050D2BG	24 V	+18 V/+90 mA, -5 V/-90 mA
PUC2420035D2BG	24 V	+20 V/+90 mA, -3.5 V/-80 mA
PUC2420050D2BG	24 V	+20 V/+80 mA, -5 V/-80 mA
PUC2415090D2BG	24 V	+15 V/+100 mA, -9 V/-60 mA
PUC2417090D2BG	24 V	+17 V/+90 mA, -9 V/-50 mA
PUC2418090D2BG	24 V	+18 V/+90 mA, -9 V/-50 mA
PUC2415150D2BG	24 V	±15 V/±67 mA

**Product number and Packaging**

PUCX <sub>1</sub> X <sub>2</sub> X <sub>3</sub> X <sub>4</sub> X <sub>5</sub> X <sub>6</sub> X <sub>7</sub> n <sub>1</sub> n <sub>2</sub> n <sub>3</sub> n <sub>4</sub> *				
Options	n <sub>1</sub>	n <sub>2</sub>	n <sub>3</sub>	n <sub>4</sub>
Single/Dual output	o			
Output Power		o		
Form factor			o	
Custom suffix				o

Options	Description
n <sub>1</sub>	D Dual Output
n <sub>2</sub>	2 2 W
n <sub>3</sub>	B SIP7
n <sub>4</sub>	G Gate Driver

Example a 24 Vdc nominal input, Dual +15/-5 Vdc output, 2 W SIP7 product would be PUC2415050D2BG.

\* X<sub>1</sub>X<sub>2</sub> = Nominal input voltage  
 X<sub>3</sub>X<sub>4</sub> = Positive output voltage  
 X<sub>5</sub>X<sub>6</sub>X<sub>7</sub> = Negative output voltage

**General Information**

**Reliability**

The failure rate ( $\lambda$ ) and mean time between failures (MTBF= 1/ $\lambda$ ) is calculated at max output power and an operating ambient temperature (T<sub>A</sub>) of +25°C. Flex uses MIL-HDBK-217F, Notice 2 to calculate the mean steady-state failure rate.

In MIL-HDBK-217F, all part reliability models include the effects of environmental stresses through the environmental factor,  $\pi E$ . It encompasses the major areas of equipment use, here we use ground benign, GB.

Mean steady-state failure rate, $\lambda$	MTBF
76.9 nFailures/h	13 Mhrs

**Compatibility with RoHS requirements**

The products are compatible with the relevant clauses and requirements of the RoHS directive 2011/65/EU and have a maximum concentration value of 0.1% by weight in homogeneous materials for lead, mercury, hexavalent chromium, PBB and PBDE and of 0.01% by weight in homogeneous materials for cadmium.

Exemptions in the RoHS directive utilized in Flex products are found in the Statement of Compliance document.

Flex fulfills and will continuously fulfill all its obligations under regulation (EC) No 1907/2006 concerning the registration, evaluation, authorization and restriction of chemicals (REACH) as they enter into force and is through product materials declarations preparing for the obligations to communicate information on substances in the products.

**Quality Statement**

The products are designed and manufactured in an industrial environment where quality systems and methods like ISO 9000, Six Sigma, and SPC are intensively in use to boost the continuous improvements strategy. Infant mortality or early failures in the products are screened out and they are subjected to an ATE-based final test. Conservative design rules, design reviews and product qualifications, plus the high competence of an engaged work force, contribute to the high quality of the products.

**Warranty**

Warranty period and conditions are defined in Flex General Terms and Conditions of Sale.

**Limitation of Liability**

Flex does not make any other warranties, expressed or implied including any warranty of merchantability or fitness for a particular purpose (including, but not limited to, use in life support applications, where malfunctions of product can cause injury to a person's health or life).

## Technical Specification

<b>PUC-D2BG series DC/DC Converters</b> Isolated 2W Unregulated Dual Output	28701-BMR808 Rev. A	March 2022
	© Flex	

**© Flex 2022**

The information and specifications in this technical specification is believed to be correct at the time of publication. However, no liability is accepted for inaccuracies, printing errors or for any consequences thereof. Flex reserves the right to change the contents of this technical specification at any time without prior notice.

<b>PUC-D2BG series DC/DC Converters</b> Isolated 2W Unregulated Dual Output	28701-BMR808 Rev. A	March 2022
	© Flex	

## Safety Specification

### General information

Flex Power DC/DC converters and DC/DC regulators are designed in accordance with the safety standards IEC 62368-1, EN 62368-1 and UL 62368-1 *Audio/video, information and communication technology equipment - Part 1: Safety requirements*

IEC/EN/UL 62368-1 contains requirements to prevent injury or damage due to the following hazards:

- Electrical shock
- Electrically-caused fire
- Injury caused by hazardous substances
- Mechanically-caused injury
- Skin burn
- Radiation-caused injury

On-board DC/DC converters, Power interface modules and DC/DC regulators are defined as component power supplies. As components they cannot fully comply with the provisions of any safety requirements without “conditions of acceptability”. Clearance between conductors and between conductive parts of the component power supply and conductors on the board in the final product must meet the applicable safety requirements. Certain conditions of acceptability apply for component power supplies with limited stand-off (see Mechanical Information for further information). It is the responsibility of the installer to ensure that the final product housing these components complies with the requirements of all applicable safety standards and regulations for the final product.

Component power supplies for general use shall comply with the requirements in IEC/EN/UL 62368-1. Product related standards, e.g. IEEE 802.3af *Power over Ethernet*, and ETS-300132-2 *Power interface at the input to telecom equipment, operated by direct current (dc)* are based on IEC/EN/UL 60950-1 with regards to safety.

Flex Power DC/DC converters, Power interface modules and DC/DC regulators are UL 62368-1 recognized and certified in accordance with EN 62368-1. The flammability rating for all construction parts of the products meet requirements for V-0 class material according to IEC 60695-11-10, *Fire hazard testing, test flames – 50 W horizontal and vertical flame test methods*.

### Isolated DC/DC converters & Power interface modules

The product may provide basic or functional insulation between input and output according to IEC/EN/UL 62368-1 (see Safety Certificate), different conditions shall be met if the output of a basic or a functional insulated product shall be considered as ES1 energy source.

For basic insulated products (see Safety Certificate) the output is considered as ES1 energy source if one of the

following conditions is met:

- The input source provides supplementary or double or reinforced insulation from the AC mains according to IEC/EN/UL 62368-1.
- The input source provides functional or basic insulation from the AC mains and the product’s output is reliably connected to protective earth according to IEC/EN/UL 62368-1.

For functional insulated products (see Safety Certificate) the output is considered as ES1 energy source if one of the following conditions is met:

- The input source provides double or reinforced insulation from the AC mains according to IEC/EN/UL 62368-1.
- The input source provides basic or supplementary insulation from the AC mains and the product’s output is reliably connected to protective earth according to IEC/EN/UL 62368-1.
- The input source is reliably connected to protective earth and provides basic or supplementary insulation according to IEC/EN/UL 62368-1 and the maximum input source voltage is 60 Vdc.

Galvanic isolation between input and output is verified in an electric strength test and the isolation voltage ( $V_{iso}$ ) meets the voltage strength requirement for basic insulation according to IEC/EN/UL 62368-1.

It is recommended to use a slow blow fuse at the input of each DC/DC converter. If an input filter is used in the circuit the fuse should be placed in front of the input filter. In the rare event of a component problem that imposes a short circuit on the input source, this fuse will provide the following functions:

- Isolate the fault from the input power source so as not to affect the operation of other parts of the system
- Protect the distribution wiring from excessive current and power loss thus preventing hazardous overheating

### Non - isolated DC/DC regulators

The DC/DC regulator output is ES1 energy source if the input source meets the requirements for ES1 according to IEC/EN/UL 62368-1.

<b>PUC-D2BG series DC/DC Converters</b> Isolated 2W Unregulated Dual Output	28701-BMR808 Rev. A	March 2022
	© Flex	

**Absolute Maximum Ratings**

Characteristics		min	typ	max	Unit
$T_{P1}$	Operating Temperature (see Thermal Consideration section)	-40		+100	°C
$T_{CASE}$	Max. case temperature			+115	°C
$T_S$	Storage temperature	-55		+125	°C
$V_I$	Input voltage Range (base on nominal input voltage)	-10		+10	%
$V_{iso}$	Isolation voltage (input to output test voltage in 1minute)			6200	Vdc

Stresses above those listed under Absolute Maximum Ratings may cause permanent damage to the device. This is a stress rating only; functional operation of the device at these or any other conditions above those indicated in the Electrical Specification section of this specification is not implied. Exposure to absolute maximum rating conditions for extended periods may affect device reliability.

**Fundamental Circuit Diagram**

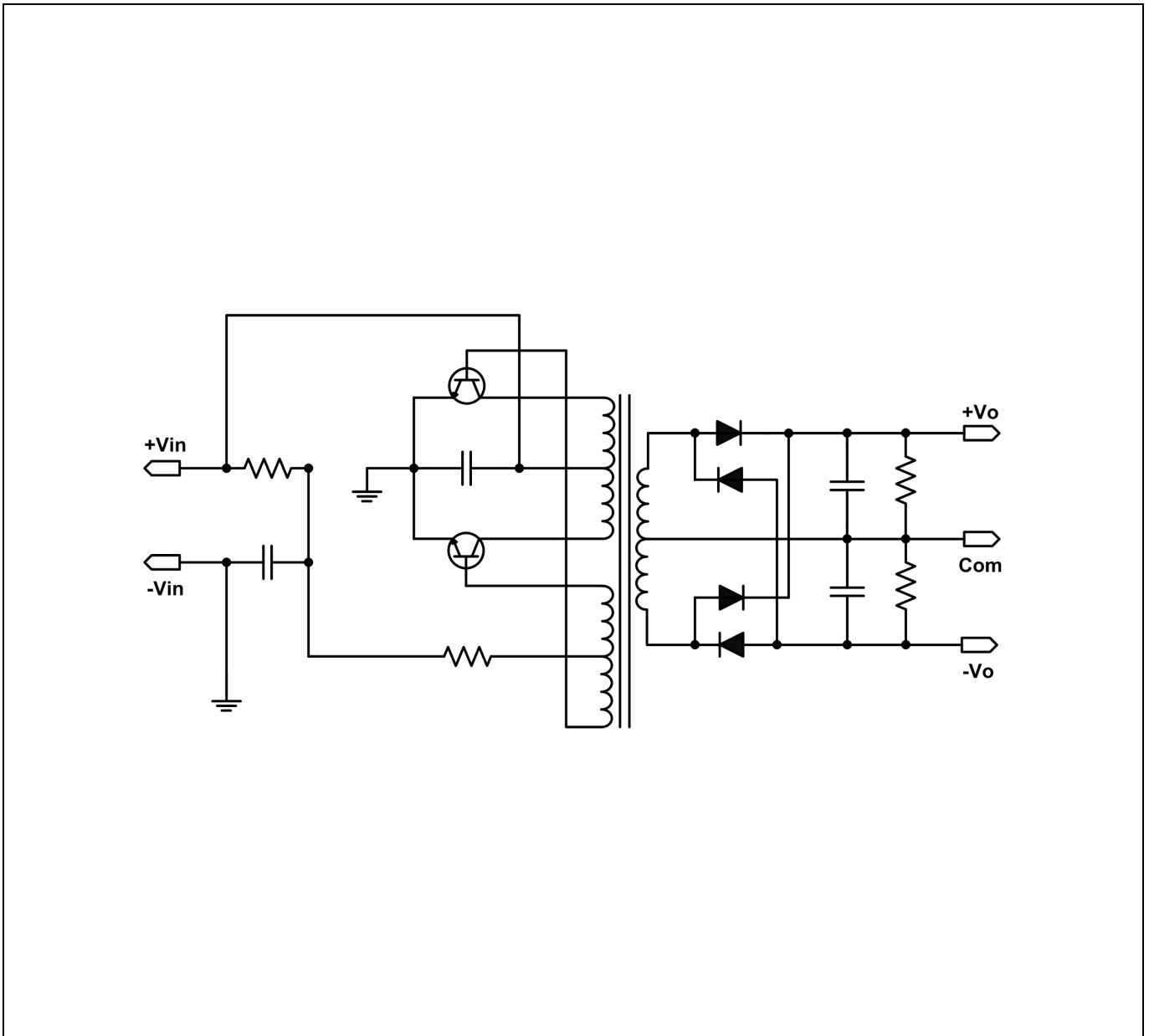

<b>PUC-D2BG series DC/DC Converters</b> Isolated 2W Unregulated Dual Output	28701-BMR808 Rev. A	March 2022
	© Flex	

**Electrical Specification****PUC-D2BG series**

Typical values given at:  $T_{P1} = +25^{\circ}\text{C}$ , unless otherwise specified under Conditions.

Part Number	Typical Input Voltage	Output Voltage	Output Current	Efficiency (typ.) 50% of max $I_o$	Efficiency (typ.) max $I_o$	Isolation capacitance (typ.) (note 1)
	V	V	mA	%	%	pF
PUC1215030D2BG	12	+15 / -3	+110 / -100	64	79	4.8
PUC1215050D2BG	12	+15 / -5	+100 / -100	70	78	4.9
PUC1218025D2BG	12	+18 / -2.5	+80 / -80	66	77	5.2
PUC1218050D2BG	12	+18 / -5	+90 / -90	66	78	4.8
PUC1220035D2BG	12	+20 / -3.5	+90 / -80	69	79	6.3
PUC1220050D2BG	12	+20 / -5	+80 / -80	69	80	6.5
PUC1215090D2BG	12	+15 / -9	+100 / -60	69	81	5.5
PUC1217090D2BG	12	+17 / -9	+90 / -50	66	78	4.4
PUC1218090D2BG	12	+18 / -9	+90 / -50	67	79	4.4
PUC1215150D2BG	12	+15 / -15	+67 / -67	66	80	5.5
PUC1515030D2BG	15	+15 / -3	+110 / -100	64	77	5.7
PUC1515050D2BG	15	+15 / -5	+100 / -100	66	79	5.2
PUC1518025D2BG	15	+18 / -2.5	+80 / -80	64	77	5.4
PUC1518050D2BG	15	+18 / -5	+90 / -90	69	81	5.4
PUC1520035D2BG	15	+20 / -3.5	+90 / -80	67	78	6.5
PUC1520050D2BG	15	+20 / -5	+80 / -80	69	80	6.1
PUC1515090D2BG	15	+15 / -9	+100 / -60	67	79	6.4
PUC1517090D2BG	15	+17 / -9	+90 / -50	67	81	6.3
PUC1518090D2BG	15	+18 / -9	+90 / -50	65	78	5.1
PUC1515150D2BG	15	+15 / -15	+67 / -67	68	77	5.5
PUC2415030D2BG	24	+15 / -3	+110 / -100	68	80	4.9
PUC2415050D2BG	24	+15 / -5	+100 / -100	72	78	4.8
PUC2418025D2BG	24	+18 / -2.5	+80 / -80	68	77	6.1
PUC2418050D2BG	24	+18 / -5	+90 / -90	68	79	6.8
PUC2420035D2BG	24	+20 / -3.5	+90 / -80	69	78	5.2
PUC2420050D2BG	24	+20 / -5	+80 / -80	69	80	5.5
PUC2415090D2BG	24	+15 / -9	+100 / -60	70	79	5.7
PUC2417090D2BG	24	+17 / -9	+90 / -50	68	80	5.6
PUC2418090D2BG	24	+18 / -9	+90 / -50	68	78	4.9
PUC2415150D2BG	24	+15 / -15	+67 / -67	68	78	5.5

Characteristics		Conditions	min	typ	max	Unit
$C_i$	Internal input capacitance			1		$\mu\text{F}$
$P_o$	Output power				2	W
$C_{LOAD}$	Capacitive Load, see Note 2				100	$\mu\text{F}$
$R_{ISO}$	Isolation resistance			10		$\text{G}\Omega$
$V_{oi}$	Voltage accuracy at typ. $V_{in}$ , $T_{P1} = +25^{\circ}\text{C}$ , $I_o = \text{max } I_o$ .	PUCxx15xxxD2BG, PUCxx17xxxD2BG, PUCxx18xxxD2BG.	-5		+5	%
		PUCxx20xxxD2BG	-8		+2	%
	Minimum load	$T_{P1} = +25^{\circ}\text{C}$	0			%
	Line regulation, see Note 3	$V_{LL}$ to $V_{HL}$ , max $I_o$		1.2		%/%
	Load regulation	$I_{LL} - I_{HL}$ , at typ. $V_{in}$		5		%
$f_s$	Switching frequency	100 % of max $I_o$ (at typ. $V_{in}$ )	20		130	kHz
$V_{Oac}$	Output ripple & noise	20 MHz BW, see Note 4		30	50	mVp-p

Note 1: The test condition of isolation capacitance is Freq: 1 kHz/Vs: 1 V

Note 2: The maximum capacitive load is tested by normal input and constant resistive load.

Note 3: The output voltage changes per input voltage changing.

Note 4: The Output ripple & noise is under nominal  $V_{in}$  and max  $I_o$  with 0.1  $\mu\text{F}$  and 10  $\mu\text{F}$  /50 V MLCC.

**PUC-D2BG series DC/DC Converters**  
Isolated 2W Unregulated Dual Output

28701-BMR808 Rev. A

March 2022

© Flex

**Typical Characteristics**

**Efficiency**

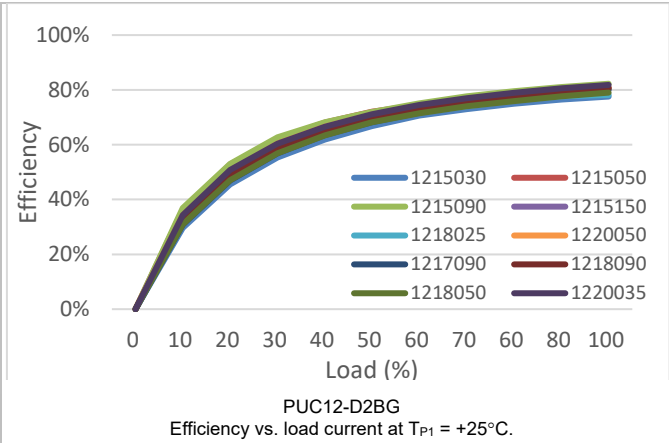

**PUC-D2BG series**

**Efficiency**

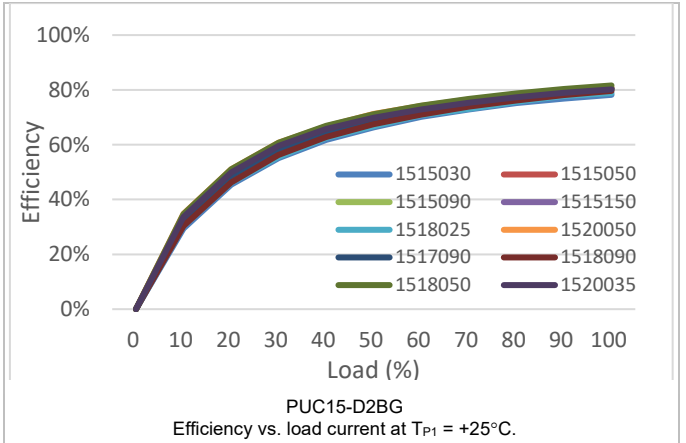

**Efficiency**

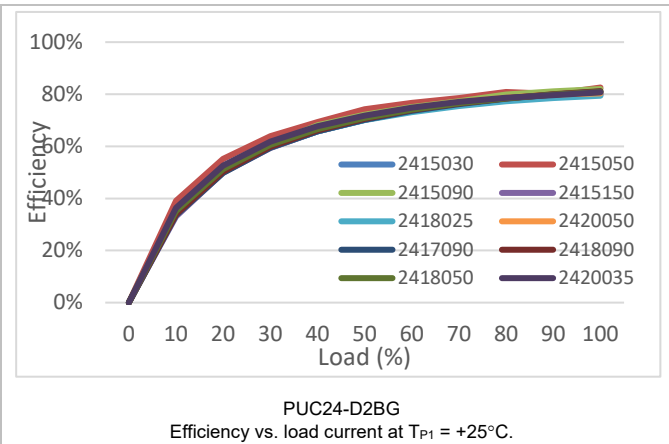

**Operating Ambient Temperature Curve**

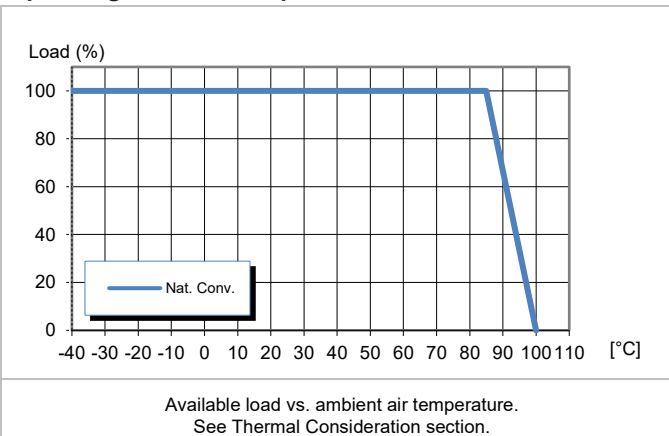

**PUC-D2BG series DC/DC Converters**  
Isolated 2W Unregulated Dual Output

28701-BMR808 Rev. A

March 2022

© Flex

**Typical Characteristics**  
**Output Voltage Accuracy**

**PUC-D2BG series**

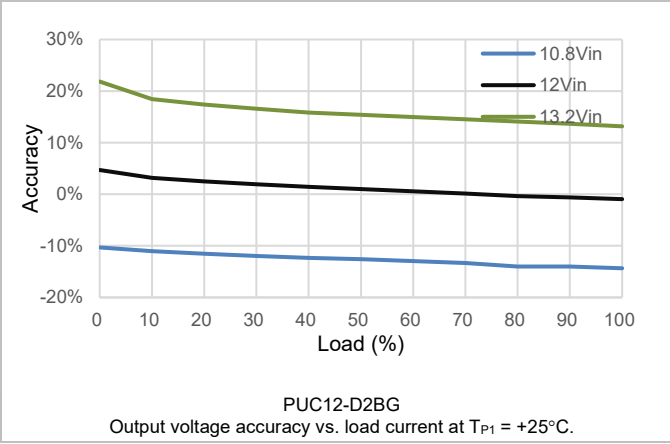

**Output Voltage Accuracy**

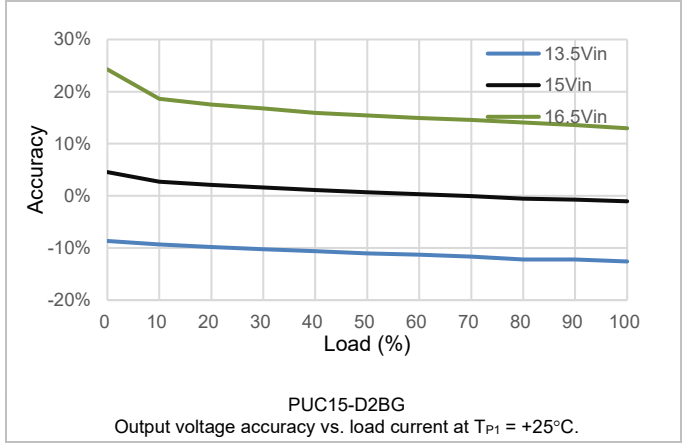

**Output Voltage Accuracy**

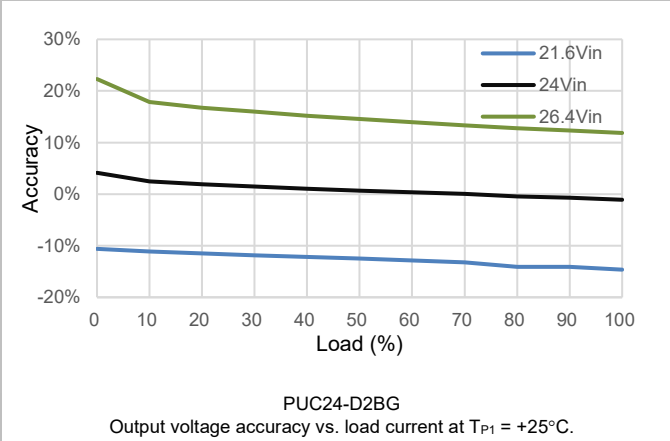

**Load Regulation**

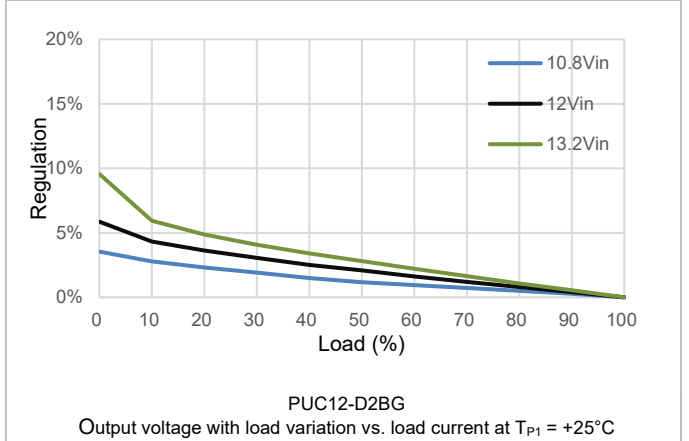

**Load Regulation**

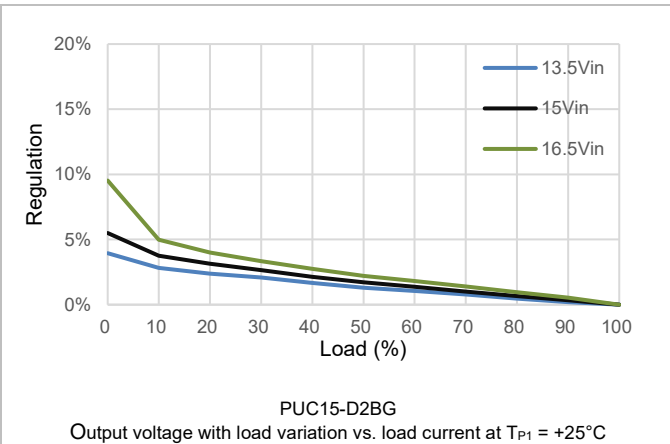

**Load Regulation**

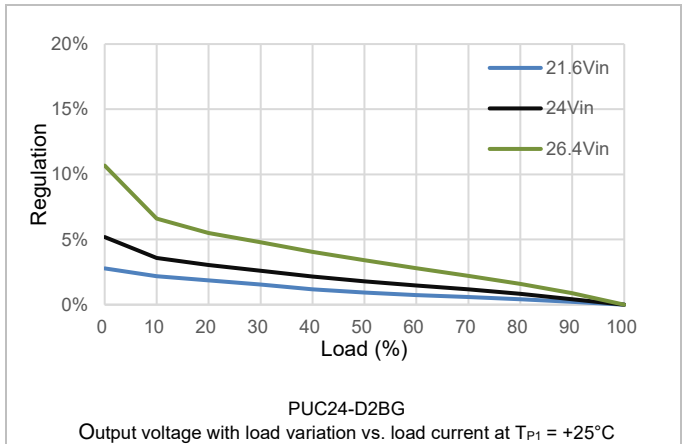



**PUC-D2BG series DC/DC Converters**  
Isolated 2W Unregulated Dual Output

28701-BMR808 Rev. A

March 2022

© Flex

**Typical Characteristics**

**Output Ripple & Noise**

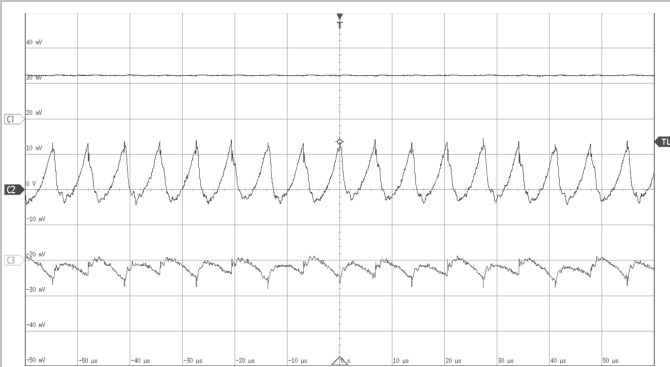

Output voltage ripple at:  
 $T_{P1} = +25^{\circ}\text{C}$ ,  $V_1 = 12\text{ V}$ ,  $V_O = +15 / -5\text{ V}$   
 $I_O = +100 / -100\text{ mA}$  resistive load.  
 20 MHz bandwidth filter +10  $\mu\text{F}$  & 0.1  $\mu\text{F}$

Top trace: Input voltage (10 V/div.).  
 Middle trace: +Output voltage (10 mV/div.).  
 Bottom trace: -Output voltage (10 mV/div.)  
 Time scale: (10  $\mu\text{s}$ /div.).

**PUC-D2BG series**

**Output Ripple & Noise**

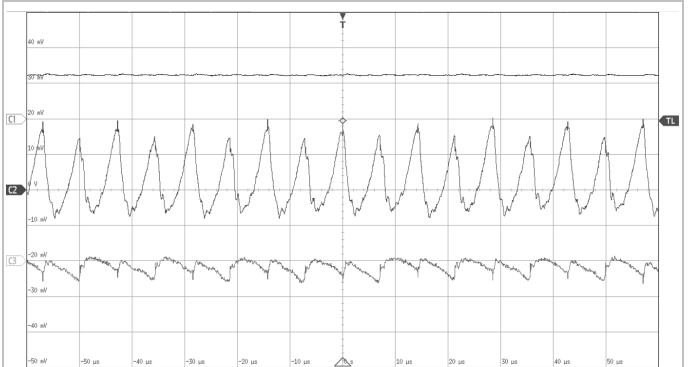

Output voltage ripple at:  
 $T_{P1} = +25^{\circ}\text{C}$ ,  $V_1 = 12\text{ V}$ ,  $V_O = +20 / -5\text{ V}$   
 $I_O = +80 / -80\text{ mA}$  resistive load.  
 20 MHz bandwidth filter +10  $\mu\text{F}$  & 0.1  $\mu\text{F}$

Top trace: Input voltage (10 V/div.).  
 Middle trace: +Output voltage (10 mV/div.).  
 Bottom trace: -Output voltage (10 mV/div.)  
 Time scale: (10  $\mu\text{s}$ /div.).

**Output Ripple & Noise**

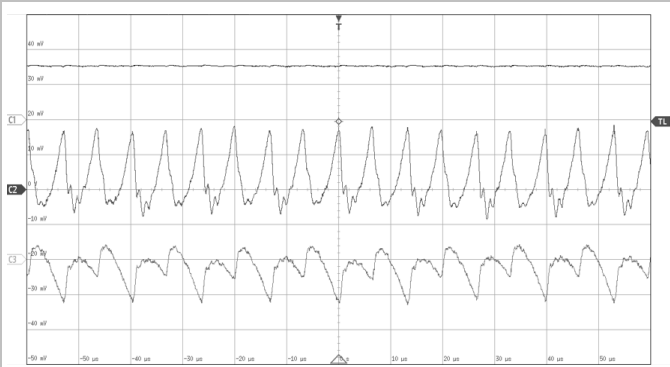

Output voltage ripple at:  
 $T_{P1} = +25^{\circ}\text{C}$ ,  $V_1 = 15\text{ V}$ ,  $V_O = +15 / -5\text{ V}$   
 $I_O = +100 / -100\text{ mA}$  resistive load.  
 20 MHz bandwidth filter +10  $\mu\text{F}$  & 0.1  $\mu\text{F}$

Top trace: Input voltage (10 V/div.).  
 Middle trace: +Output voltage (10 mV/div.).  
 Bottom trace: -Output voltage (10 mV/div.)  
 Time scale: (10  $\mu\text{s}$ /div.).

**Output Ripple & Noise**

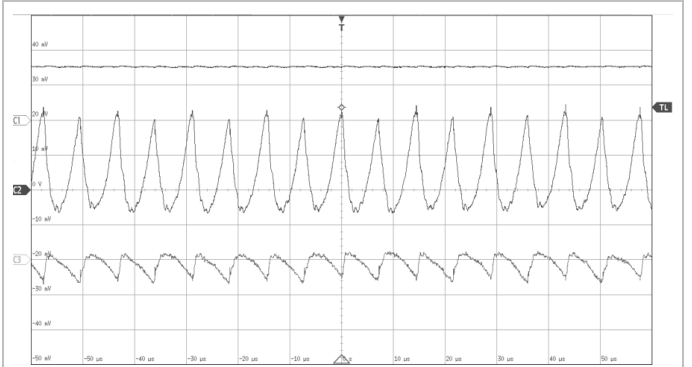

Output voltage ripple at:  
 $T_{P1} = +25^{\circ}\text{C}$ ,  $V_1 = 15\text{ V}$ ,  $V_O = +20 / -5\text{ V}$   
 $I_O = +80 / -80\text{ mA}$  resistive load.  
 20 MHz bandwidth filter +10  $\mu\text{F}$  & 0.1  $\mu\text{F}$

Top trace: Input voltage (10 V/div.).  
 Middle trace: +Output voltage (10 mV/div.).  
 Bottom trace: -Output voltage (10 mV/div.)  
 Time scale: (10  $\mu\text{s}$ /div.).

**Output Ripple & Noise**

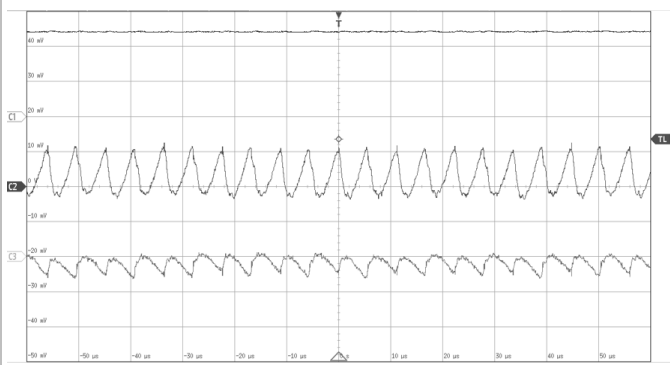

Output voltage ripple at:  
 $T_{P1} = +25^{\circ}\text{C}$ ,  $V_1 = 24\text{ V}$ ,  $V_O = +15 / -5\text{ V}$   
 $I_O = +100 / -100\text{ mA}$  resistive load.  
 20 MHz bandwidth filter +10  $\mu\text{F}$  & 0.1  $\mu\text{F}$

Top trace: Input voltage (10 V/div.).  
 Middle trace: +Output voltage (10 mV/div.).  
 Bottom trace: -Output voltage (10 mV/div.)  
 Time scale: (10  $\mu\text{s}$ /div.).

**Output Ripple & Noise**

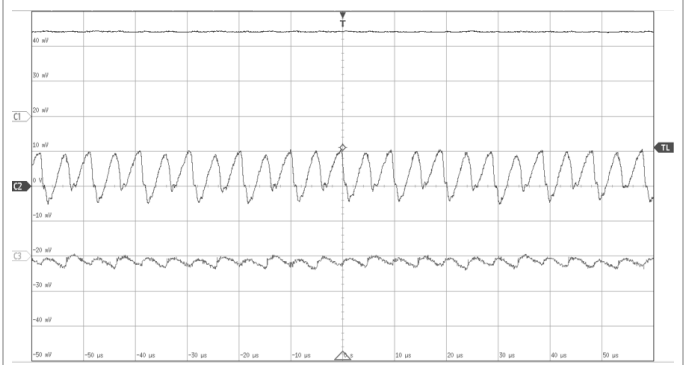

Output voltage ripple at:  
 $T_{P1} = +25^{\circ}\text{C}$ ,  $V_1 = 24\text{ V}$ ,  $V_O = +20 / -5\text{ V}$   
 $I_O = +80 / -80\text{ mA}$  resistive load.  
 20 MHz bandwidth filter +10  $\mu\text{F}$  & 0.1  $\mu\text{F}$

Top trace: Input voltage (10 V/div.).  
 Middle trace: +Output voltage (10 mV/div.).  
 Bottom trace: -Output voltage (10 mV/div.)  
 Time scale: (10  $\mu\text{s}$ /div.).

**PUC-D2BG series DC/DC Converters**  
Isolated 2W Unregulated Dual Output

28701-BMR808 Rev. A

March 2022

© Flex

**Typical Characteristics**

**PUC-D2BG series**

**Start-up**

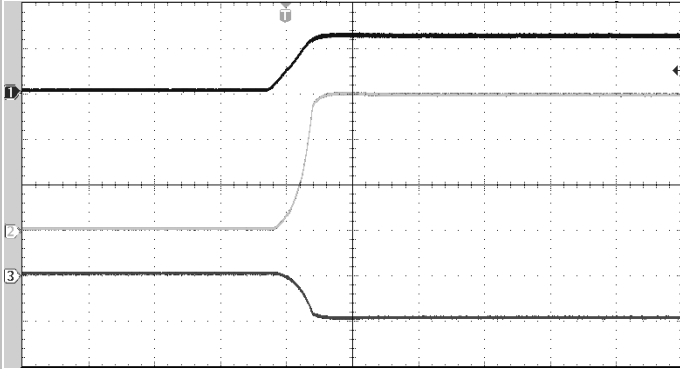

Start-up, enabled by connecting  $V_i$  at:  
 $T_{P1} = +25^{\circ}\text{C}$ ,  $V_i = 12\text{ V}$ ,  $V_o = +15 / -5\text{ V}$   
 $I_o = +100 / -100\text{ mA}$  resistive load.

Top trace: Input voltage (10 V/div.).  
Middle trace: +Output voltage (5 V/div.).  
Bottom trace: -Output voltage (5 V/div.).  
Time scale: (2 ms/div.).

**Shut-down**

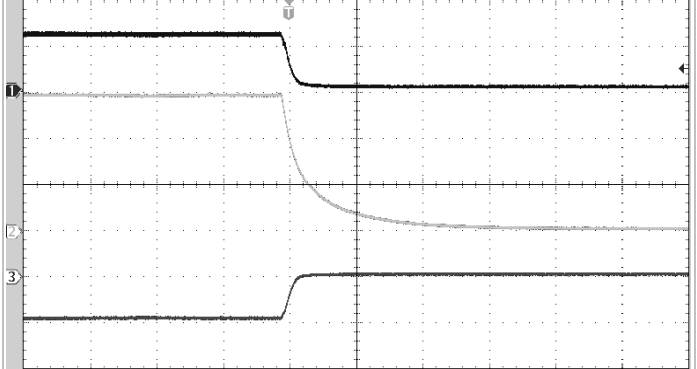

Start-up, enabled by connecting  $V_i$  at:  
 $T_{P1} = +25^{\circ}\text{C}$ ,  $V_i = 12\text{ V}$ ,  $V_o = +15 / -5\text{ V}$   
 $I_o = +100 / -100\text{ mA}$  resistive load.

Top trace: Input voltage (10 V/div.).  
Middle trace: +Output voltage (5 V/div.).  
Bottom trace: -Output voltage (5 V/div.).  
Time scale: (2 ms/div.).

**Start-up**

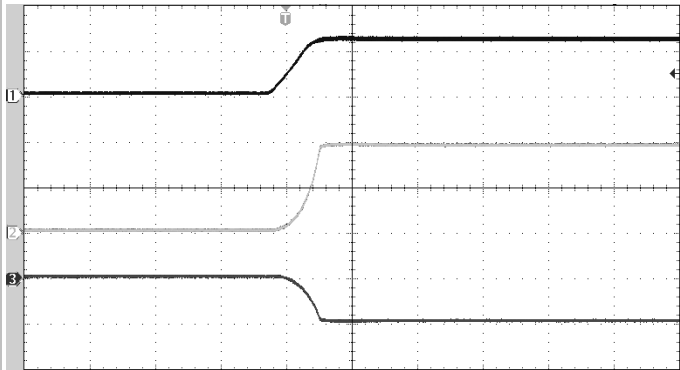

Start-up, enabled by connecting  $V_i$  at:  
 $T_{P1} = +25^{\circ}\text{C}$ ,  $V_i = 12\text{ V}$ ,  $V_o = +20 / -5\text{ V}$   
 $I_o = +80 / -80\text{ mA}$  resistive load.

Top trace: Input voltage (10 V/div.).  
Middle trace: +Output voltage (10 V/div.).  
Bottom trace: -Output voltage (5 V/div.).  
Time scale: (2ms/div.).

**Shut-down**

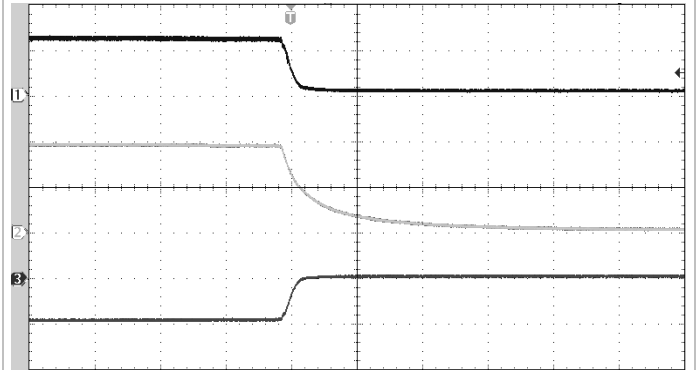

Start-up, enabled by connecting  $V_i$  at:  
 $T_{P1} = +25^{\circ}\text{C}$ ,  $V_i = 12\text{ V}$ ,  $V_o = +20 / -5\text{ V}$   
 $I_o = +80 / -80\text{ mA}$  resistive load.

Top trace: Input voltage (10 V/div.).  
Middle trace: +Output voltage (10 V/div.).  
Bottom trace: -Output voltage (5 V/div.).  
Time scale: (2ms/div.).

**Start-up**

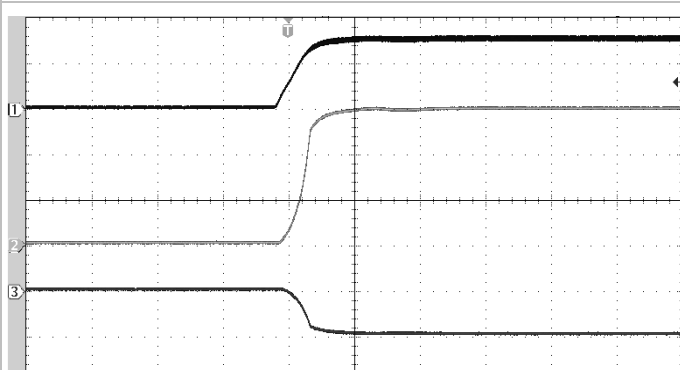

Start-up, enabled by connecting  $V_i$  at:  
 $T_{P1} = +25^{\circ}\text{C}$ ,  $V_i = 15\text{ V}$ ,  $V_o = +15 / -5\text{ V}$   
 $I_o = +100 / -100\text{ mA}$  resistive load.

Top trace: Input voltage (10 V/div.).  
Middle trace: +Output voltage (5 V/div.).  
Bottom trace: -Output voltage (5 V/div.).  
Time scale: (2 ms/div.).

**Shut-down**

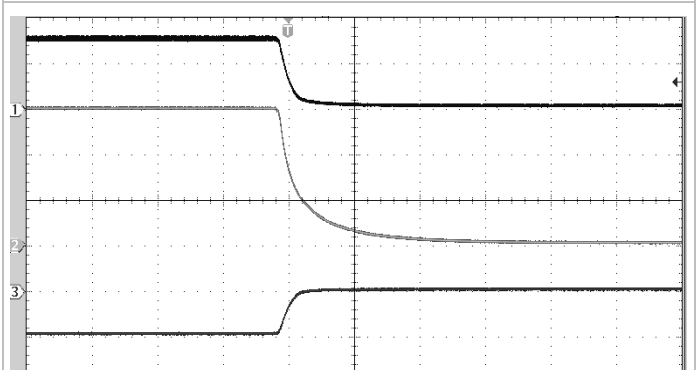

Start-up, enabled by connecting  $V_i$  at:  
 $T_{P1} = +25^{\circ}\text{C}$ ,  $V_i = 15\text{ V}$ ,  $V_o = +15 / -5\text{ V}$   
 $I_o = +100 / -100\text{ mA}$  resistive load.

Top trace: Input voltage (10 V/div.).  
Middle trace: +Output voltage (5 V/div.).  
Bottom trace: -Output voltage (5 V/div.).  
Time scale: (2 ms/div.).

**PUC-D2BG series DC/DC Converters**  
Isolated 2W Unregulated Dual Output

28701-BMR808 Rev. A

March 2022

© Flex

**Typical Characteristics**

**PUC-D2BG series**

**Start-up**

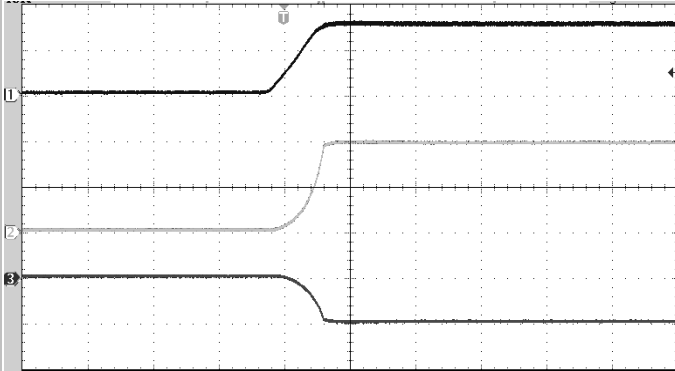

Start-up, enabled by connecting  $V_i$  at:  
 $T_{P1} = +25^\circ\text{C}$ ,  $V_i = 15\text{ V}$ ,  $V_o = +20 / -5\text{ V}$   
 $I_o = +80 / -80\text{ mA}$  resistive load.

Top trace: Input voltage (10 V/div.).  
Middle trace: +Output voltage (10 V/div.).  
Bottom trace: -Output voltage (5 V/div.).  
Time scale: (2 ms/div.).

**Shut-down**

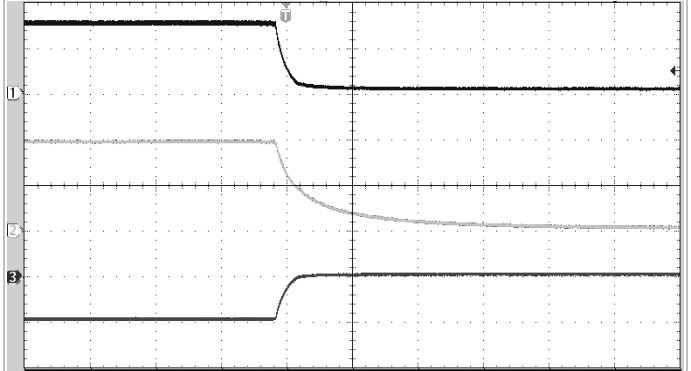

Start-up, enabled by connecting  $V_i$  at:  
 $T_{P1} = +25^\circ\text{C}$ ,  $V_i = 15\text{ V}$ ,  $V_o = +20 / -5\text{ V}$   
 $I_o = +80 / -80\text{ mA}$  resistive load.

Top trace: Input voltage (10 V/div.).  
Middle trace: +Output voltage (10 V/div.).  
Bottom trace: -Output voltage (5 V/div.).  
Time scale: (2 ms/div.).

**Start-up**

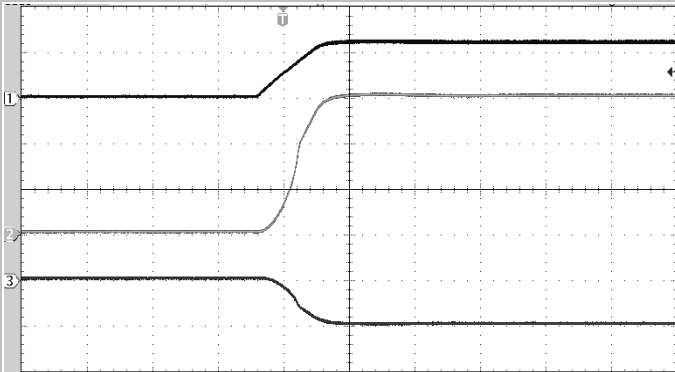

Start-up, enabled by connecting  $V_i$  at:  
 $T_{P1} = +25^\circ\text{C}$ ,  $V_i = 24\text{ V}$ ,  $V_o = +15 / -5\text{ V}$   
 $I_o = +100 / -100\text{ mA}$  resistive load.

Top trace: Input voltage (20 V/div.).  
Middle trace: +Output voltage (5 V/div.).  
Bottom trace: -Output voltage (5 V/div.).  
Time scale: (2 ms/div.).

**Shut-down**

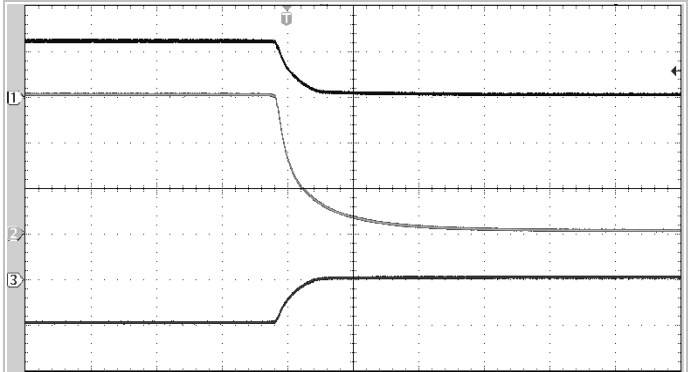

Start-up, enabled by connecting  $V_i$  at:  
 $T_{P1} = +25^\circ\text{C}$ ,  $V_i = 24\text{ V}$ ,  $V_o = +15 / -5\text{ V}$   
 $I_o = +100 / -100\text{ mA}$  resistive load.

Top trace: Input voltage (20 V/div.).  
Middle trace: +Output voltage (5 V/div.).  
Bottom trace: -Output voltage (5 V/div.).  
Time scale: (2 ms/div.).

**Start-up**

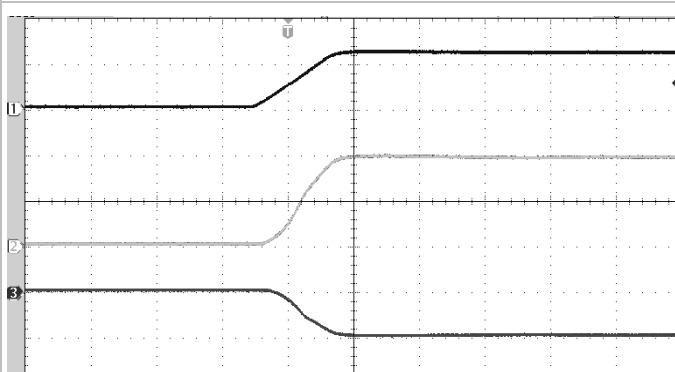

Start-up, enabled by connecting  $V_i$  at:  
 $T_{P1} = +25^\circ\text{C}$ ,  $V_i = 24\text{ V}$ ,  $V_o = +20 / -5\text{ V}$   
 $I_o = +80 / -80\text{ mA}$  resistive load.

Top trace: Input voltage (20 V/div.).  
Middle trace: +Output voltage (10 V/div.).  
Bottom trace: -Output voltage (5 V/div.).  
Time scale: (2 ms/div.).

**Shut-down**

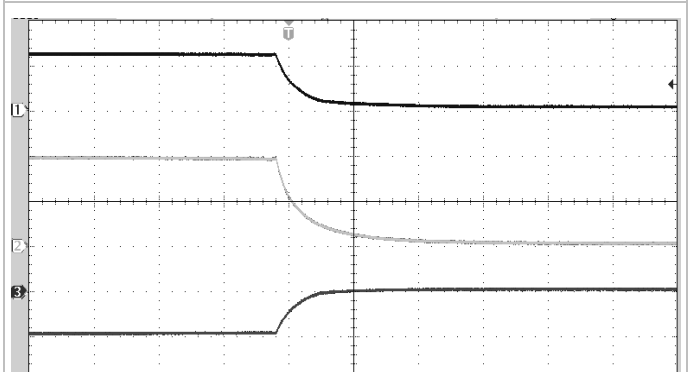

Start-up, enabled by connecting  $V_i$  at:  
 $T_{P1} = +25^\circ\text{C}$ ,  $V_i = 24\text{ V}$ ,  $V_o = +20 / -5\text{ V}$   
 $I_o = +80 / -80\text{ mA}$  resistive load.

Top trace: Input voltage (20 V/div.).  
Middle trace: +Output voltage (10 V/div.).  
Bottom trace: -Output voltage (5 V/div.).  
Time scale: (2 ms/div.).

**PUC-D2BG series DC/DC Converters**  
Isolated 2W Unregulated Dual Output

28701-BMR808 Rev. A

March 2022

© Flex

**EMC Specification**

Conducted EMI measured according to EN55032, CISPR 32 and FCC part 15J (see test set-up). See Design Note 029 for further information. The minimum switching frequency is 20 kHz. The EMI characteristics below is measured at max I<sub>o</sub>.

**Optional external filter for class B**

Suggested external input filter in order to meet class B in EN 55032, CISPR 32 and FCC part 15J.

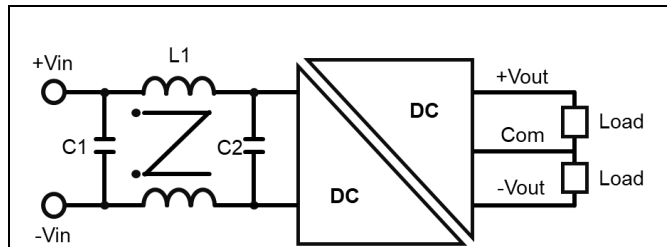

Series	C1	L1	C2
PUC12xxxxxD2BG	10 μF	0.91 mH	10 μF
PUC15xxxxxD2BG	10 μF	0.91 mH	10 μF
PUC24xxxxxD2BG	10 μF	0.91 mH	10 μF

Base on different application or PCB layout condition, the EMI requirement maybe different.

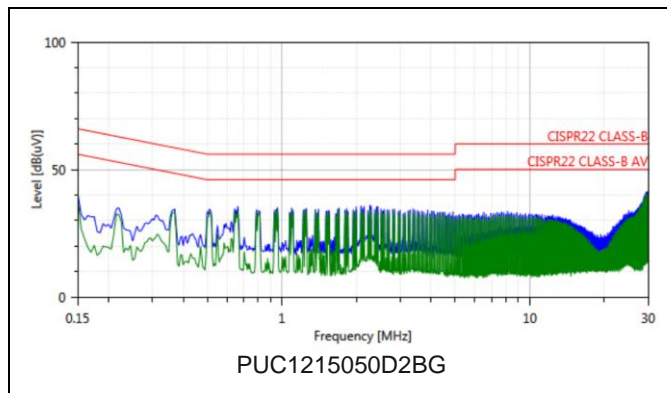

EMI with filter

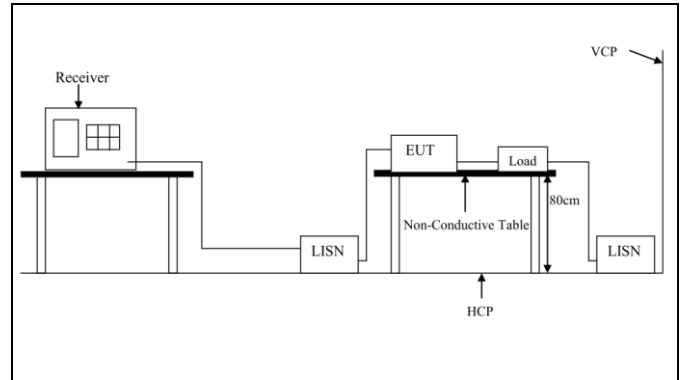

Test set-up

**Layout recommendations**

The radiated EMI performance of the product will depend on the PWB layout and ground layer design. It is also important to consider the stand-off of the product. If a ground layer is used, it should be connected to the output of the product and to the equipment ground or chassis.

A ground layer will increase the stray capacitance in the PWB and improve the high frequency EMC performance.

**Output ripple and noise**

Output ripple and noise is measured according to figure below. See Design Note 022 for detailed information.

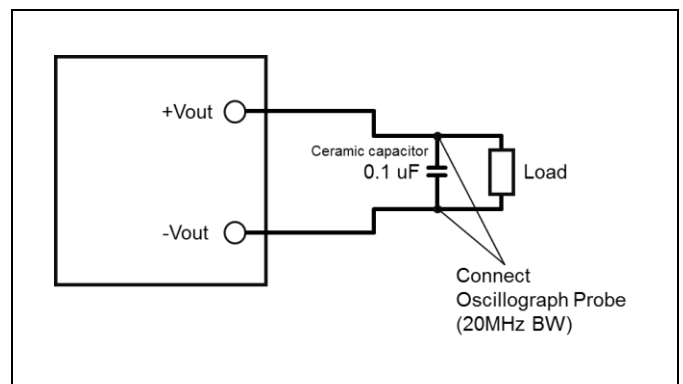

Output ripple and noise test setup

<b>PUC-D2BG series DC/DC Converters</b> Isolated 2W Unregulated Dual Output	28701-BMR808 Rev. A	March 2022
	© Flex	

## Operating Information

### Input Voltage

Converter with 10% input voltage range, mainly for isolated power in industrial applications. For example, the input voltage range 10.8 to 13.2 Vdc meets requirement of general industrial used for 12Vdc system.

The input voltage should never exceed the absolute voltage of the converter, and the ambient temperature must be limited to absolute max +100°C.

The output voltage related to input voltage. Take 12Vin and  $\pm 15V_o$  product as an example, if input voltage above 12V, the output voltage will higher than  $\pm 15V$ . Below 12V and the output voltage starts to track the input voltage.

Short duration transient disturbances can occur on the DC distribution and input of the product when a short circuit fault occurs on the equipment side of a protective device (fuse or circuit breaker). The voltage level, duration and energy of the disturbance are dependent on the particular DC distribution network characteristics and can be sufficient to damage the product unless measures are taken to suppress or absorb this energy. The transient voltage can be limited by capacitors and other energy absorbing devices like Zener diodes connected across the positive and negative input conductors at a number of strategic points in the distribution network. The end-user must secure that the transient voltage will not exceed the value stated in the Absolute maximum ratings. ETSI TR 100 283 examines the parameters of DC distribution networks and provides guidelines for controlling the transient and reduce its harmful effect.

### Turn-off Input Voltage

The products do not have under voltage lock-out function. Please make sure the input voltage of each module is correct working range.

### Input and Output Impedance

The impedance of both the input source and the load will interact with the impedance of the product. It is important that the input source has low characteristic impedance. The product are designed for stable operation without external capacitors. With a 10uF capacitors connected to the input could reduce the input noise cause by parasitic inductance.

### External Decoupling Capacitors

When powering loads with significant dynamic current requirements, the voltage regulation at the load can be improved by addition of decoupling capacitors at the load. The most effective technique is to locate low ESR ceramic and electrolytic capacitors as close to the load as possible, using several parallel capacitors to lower the effective ESR. The ceramic capacitors will handle high-frequency dynamic load changes while the electrolytic capacitors are used to handle

low frequency dynamic load changes. It is equally important to use low resistance and low inductance PWB layouts and cabling.

External decoupling capacitors will become part of the product's control loop. The control loop is optimized for a wide range of external capacitance and the maximum and minimum recommended value that could be used without any additional analysis is found in the Electrical specification. The ESR of the capacitors is a very important parameter. Stable operation is guaranteed with a verified ESR value of  $>1 \text{ m}\Omega$  across the output connections.

For further information please contact your local Flex Power Modules representative.

### Parallel Operation

This product is not designed for paralleling without using external current sharing circuits. See Design Note 006 for detailed information.

### Short Circuit Protection (SCP)

The products include short circuit protection for protect converter short circuit at output. The SCP works in a hiccup mode and will make continuous attempts to start up and will resume normal operation automatically after removal of the over current condition.

**PUC-D2BG series DC/DC Converters**  
Isolated 2W Unregulated Dual Output

28701-BMR808 Rev. A

March 2022

© Flex

**Thermal Consideration**

**General**

The products are designed to operate in different thermal environments and sufficient cooling must be provided to ensure reliable operation.

For products mounted on a PWB without a baseplate attached, cooling is achieved mainly by conduction, from the pins to the host board, and convection, which is dependant on the airflow across the product. Increased airflow enhances the cooling of the product. The Output Current Derating graph found in the Output section for each model provides the available output current vs. ambient air temperature and air velocity.

The product is tested on a 95 x 85 mm, 35 µm (1 oz), 2-layer test board mounted horizontally in a space with a volume of 300(L) x 300(W) x 200(H) mm.

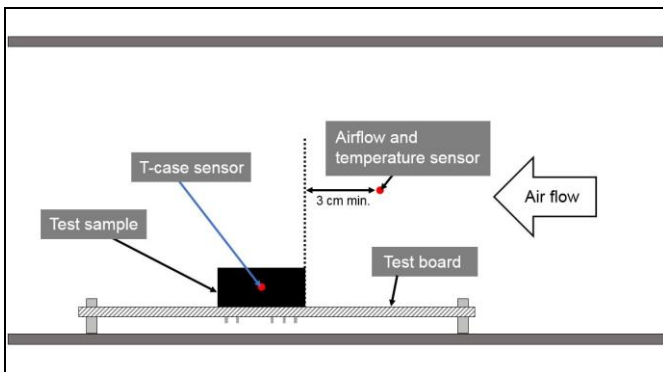

**Definition of product operating temperature**

The temperature at the positions ( $T_{P1}$ ) should not exceed the maximum temperatures in the table below. The number of measurement points may vary with different thermal design and topology. Temperatures above maximum measured at the reference point P1 are not allowed and may cause permanent damage.

Position	Description	Max Temp.
P1	Driver, Reference point	$T_{P1}=115^{\circ}C$

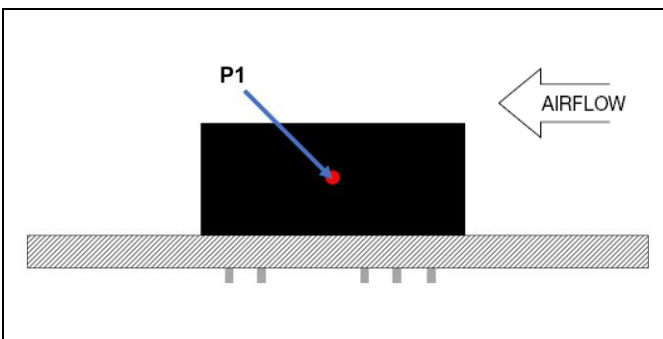

Pin side (baseplate module)

**Connections**

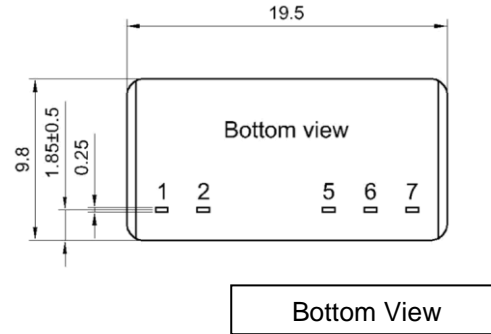

**PUCxxxxxxD2BG series**

Pin	Designation	Function
1	+Vin	Positive Input
2	-Vin	Negative Input
5	-Vo	Negative Output
6	COM	Com
7	+Vo	Positive Output

Technical Specification

**PUC-D2BG series DC/DC Converters**  
Isolated 2W Unregulated Dual Output

28701-BMR808 Rev. A

March 2022

© Flex

**Mechanical Information – Through Hole Mounting**

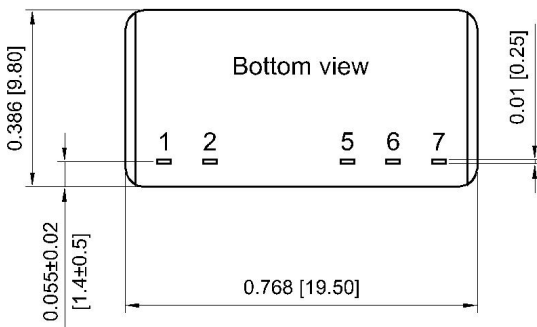
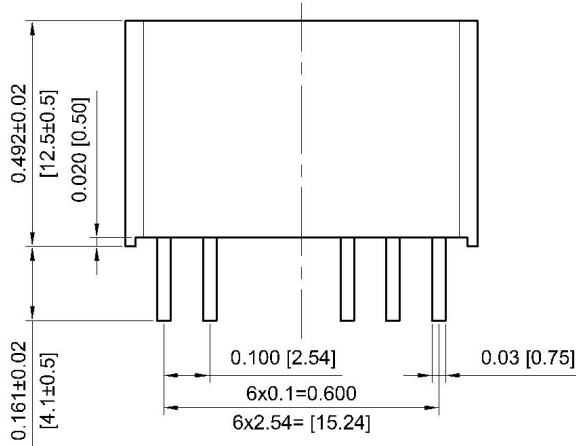

Projection : Third angle projection

Unit : inch [mm]

Tolerance inch millimeters

X.XXX±0.01 X.XX±0.25

PIN Tol ±0.004 ±0.1

**Recommended Footprint**

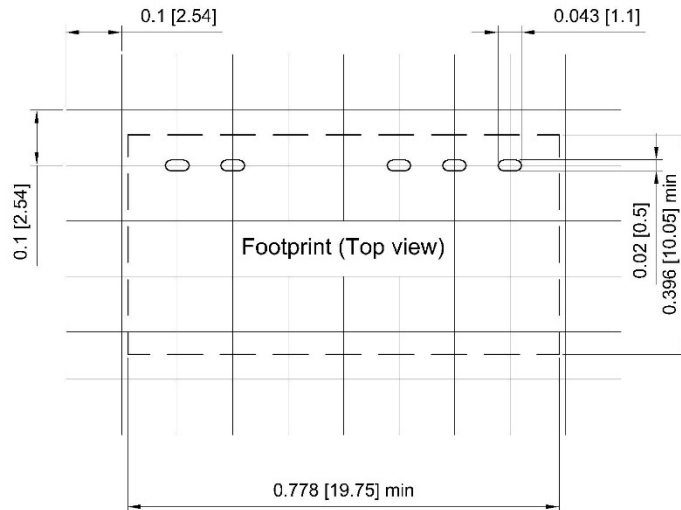

All component placements – whether shown as physical components or symbolical outline – are for reference only and are subject to change throughout the product's life cycle, unless explicitly described and dimensioned in this drawing.

<b>PUC-D2BG series DC/DC Converters</b> Isolated 2W Unregulated Dual Output	28701-BMR808 Rev. A	March 2022
	© Flex	

**Soldering Information – Through Hole Mounting**

The hole mounted product is intended for plated through hole mounting by wave or manual soldering. The pin temperature is specified to maximum to 260°C for maximum 5 seconds.

A maximum preheat rate of 4°C/s and maximum preheat temperature of 150°C is suggested. When soldering by hand, care should be taken to avoid direct contact between the hot soldering iron tip and the pins for more than a few seconds in order to prevent overheating.

A no-clean flux is recommended to avoid entrapment of cleaning fluids in cavities inside the product or between the product and the host board. The cleaning residues may affect long time reliability and isolation voltage.

**Delivery Package Information**

The products are delivered in antistatic tube.

Tube Specifications – SIP	
<b>Material</b>	Antistatic PS
<b>Surface resistance</b>	$10^5 < \text{Ohm/square} < 10^{12}$
<b>Tube length</b>	520 mm 20.47 [ inch]
<b>Tube capacity</b>	25 products (25 full tubes/box)
<b>Tube weight</b>	35.4 g empty, 135.4 g full tube

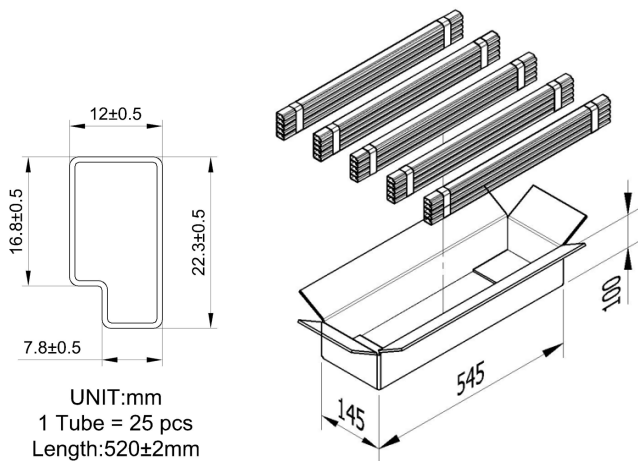

1 Tube=25 pcs  
 1 BOX = 25 (pcs/tube) \* 5 (tube/bundle) \* 5 (bundle) = 625 pcs  
 1 BOX = 625 converters  
 All dimensions in mm  
 Note: pick up positions refer to center of pocket.  
 See mechanical drawing for exact location on product.



## Technical Specification

<b>PUC-D2BG series DC/DC Converters</b> Isolated 2W Unregulated Dual Output	28701-BMR808 Rev. A	March 2022
	© Flex	

**Product Qualification Specification**

Characteristics			
External visual inspection	IPC-A-610		
Change of temperature (Temperature cycling)	MIL-STD-202G, method 107G	Temperature range Number of cycles Dwell/transfer time	-55 to 125°C 300 30 min/0-1 min
Cold (in operation)	IEC 60068-2-1 Ad	Temperature T <sub>A</sub> Duration	-40°C 72 h
Damp heat	MIL-STD-202G, Method 103B	Temperature Humidity Duration	85°C 95 % RH 1000 hours
Dry heat	IEC 60068-2-2 Bd	Temperature Duration	125°C 1000 h
Electrostatic discharge susceptibility	IEC 61000-4-2	Air model Contact model	15 kV 8 kV
Mechanical shock	MIL-STD-202G, method 213B	Peak acceleration Duration	100 g 6 ms
Operational life test	MIL-STD-202G, method 108A	Duration	1000 h
Resistance to soldering heat <sup>1</sup>	MIL-STD-202G, method 210F	Solder temperature Duration	260°C 10 s
Robustness of terminations	IEC 60068-2-21 Test Ua1 IEC 60068-2-21 Test Ue1	Through hole mount products Surface mount products	All leads All leads
Solderability	J-STD-002	Preconditioning Temperature, Pb-free	Steam ageing 8 h 245°C
Vibration	MIL-STD-202G, method 201A	Frequency Displacement Duration	10 to 55 Hz 0.06 inch 2 h in each direction

## Notes

<sup>1</sup> Only for products intended for wave soldering (plated through hole products)