



**1. AC Input Characteristics:**

- 1.1 Input Voltage Range: 90Vac-264Vac, Active PFC, single phase.
- 1.2 Normal Voltage Range: 100Vac-240Vac.
- 1.3 Input Frequency Range: 47 Hz -63 Hz.
- 1.4 Normal Frequency Range: 50Hz-60Hz.
- 1.5 Max. Input AC Current: 15A Max. @ 115Vac, 7.5A MAX. @ 230Vac.
- 1.6 Inrush Current:  
No hazard or component damage shall be occurred to power supply.
- 1.7 Efficiency:

The efficiency shall be more than 80% ,87% , 90%, 87% at below test condition  
(Without output cable)

Vin= 115Vac/60Hz ,230Vac/50Hz:

Loading	+5V(A)	+3.3V(A)	+12V(A)	-12V(A)	+5Vsb(A)	Eff%
Light Load(10%)	1.243	1.243	6.09	0.0258	0.2579	80%
Light Load (20%)	2.49	2.49	12.18	0.05	0.52	87%
Half Load (50%)	6.22	6.22	30.45	0.13	1.29	90%
Max Load (100%)	12.43	12.43	60.9	0.258	2.579	87%

1.8 EUP requirements/Standby Efficiency:

AC input power should be under 0.5W, when +5VSB output is 0.225W and measure at 115V/60Hz and 230V/50Hz

1.9 Power factor : 0.9 min@ AC 115V/60HZ,230V/50HZ at full load °

1.10 Current harmonic:

With active PFC function to meet EN61000-3-2 class D harmonic current requirement for 230Vac/50Hz.

 <b>台達電子工業股份有限公司</b> <b>DELTA ELECTRONICS, INC.</b>				DESCRIPTION: <b>電氣規格 (Electrical Specification)</b>	
THESE DRAWINGS AND SPECIFICATIONS ARE THE PROPERTY OF DELTA ELECTRONICS, INC. AND SHALL NOT BE REPRODUCED OR USED AS THE BASIS FOR THE MANUFACTURE OR SELL OF APPARATUSES OR DEVICES WITHOUT PERMISSION.				MODEL NO. <b>GPS-850LB A</b>	
Date	Drawn	Design(EE)	Design(ME)	DOCUMENT NO. :	REV.
08/26/'21	敖變鳳	董占強	宋廣	<b>ES-850LB A</b>	<b>S01</b>

With active PFC function to meet JIS C61000-3-2 class D harmonic current requirement for 100Vac/60Hz.

The class limits must be meet at max load and at 50% max load

## 2. DC Output Characteristics:

### 2.1 Static Output Characteristics:

Output Voltage	Load Range		Regulation	Ripple & noise
	Min.	Max.		
1. +5 V	0A	20A	+5% ~ -5%	50mv
2. +3.3V	0A	20A	+5% ~ -5%	50mv
3. +12V	0A	70.84A	+5% ~ -5%	120mv
4. -12V	0A	0.3A	+10% ~ -10%	120mv
5. +5Vsb	0A	3A	+5% ~ -5%	50mv

Max. Power Output: 850W

### 2.2 DC output cross regulation:

	+5V Current (A)	+3.3V Current (A)	+12V Current (A)	-12V Current (A)	+5Vsb Current (A)	
1	0	0	0	0	0	No load
2	0.2	0.2	0.2	0.1	0.1	Min load
3	20	6.06	59.28	0.3	3	
4	10.8	20	59.28	0.3	3	
5	0.2	0.2	70.84	0.1	0.1	
6	12.43	12.43	60.9	0.258	2.579	
7	6.22	6.22	30.45	0.13	1.29	

 <b>台達電子工業股份有限公司</b> <b>DELTA ELECTRONICS, INC.</b>				DESCRIPTION: <b>電氣規格 (Electrical Specification)</b>	
THESE DRAWINGS AND SPECIFICATIONS ARE THE PROPERTY OF DELTA ELECTRONICS, INC. AND SHALL NOT BE REPRODUCED OR USED AS THE BASIS FOR THE MANUFACTURE OR SELL OF APPARATUSES OR DEVICES WITHOUT PERMISSION.				MODEL NO. <b>GPS-850LB A</b>	
Date	Drawn	Design(EE)	Design(ME)	DOCUMENT NO. :	
08/26/'21	敖變鳳	董占強	宋廣	<b>ES-850LB A</b>	
				REV.	<b>S01</b>

8	2.49	2.49	12.18	0.05	0.52	
9	1	1	7	0.03	0.3	
10	0.5	0.5	4	0.02	0.2	
11	Remote off				0	
12	Remote off				3	

Note: 1. Noise Test: Noise bandwidth is from 10Hz to 20 MHz.

2. Add a 0.1  $\mu$ F ceramic disk capacitor and 10 $\mu$ F tantalum capacitor at output connector terminals for Ripple & Noise measurements.
3. Maximum Continuous Output Power shall not exceed 850W (load de-rating from 100% to 80% ,when operating temperature from 40° C to 50° C, each output decrease in proportion).
4. +3.3V and +5V total o/p power can not exceed 120W.
5. Main O/P shall be enabled by pulled "remote" pin to TTL low level, and disabled by pulled "remote" pin to TTL high level.
6. When AC line power is applied, the +5VSB will present, and PS -ON signal is in a disable state, the +5VSB o/p shall be within regulation spec limit.
7. Others
  - A. Load 1 only for PSU startup test no need test other functions.
  - B. The PG normal output voltage is 5V and regulation: +/-10%.
  - C. Cross regulations/Ripple &Noise test must with fan cooling and following the defined "DC Output Load.
  - D. Load 2 is min load for PSU function test.

### 2.3. Overshoot:

At turn on or turn off shall be less than 10% of the normal Value.

### 2.4. Dynamic Output Characteristics:

 <b>台達電子工業股份有限公司</b> <b>DELTA ELECTRONICS, INC.</b>				DESCRIPTION:	
				電氣規格 (Electrical Specification)	
<small>THESE DRAWINGS AND SPECIFICATIONS ARE THE PROPERTY OF DELTA ELECTRONICS, INC. AND SHALL NOT BE REPRODUCED OR USED AS THE BASIS FOR THE MANUFACTURE OR SELL OF APPARATUSES OR DEVICES WITHOUT PERMISSION.</small>				MODEL NO.	
				<b>GPS-850LB A</b>	
Date	Drawn	Design(EE)	Design(ME)	DOCUMENT NO. :	
08/26/'21	敖變鳳	董占強	宋廣	<b>ES-850LB A</b>	
				REV.	<b>S01</b>

TABLE  
TRANSIENT VOLTAGE TOLERANCE

NOM. OUTPUT VOLTAGE (VDC)	Current Imin (ADC)	CURRENT Imax (ADC)	Step Load Change (%)	TRANSIENT TOLERANCE (%)	OUTPUT LOAD CAPACITANCE (μF)
5V	0.2	20	30	±5	4700
12V	0.2	70.84	30	±5	2200
3.3V	0.2	20	30	±5	4700
5Vsb	0.1	3	16.7	±5	1000
-12V	0.1	0.3	33.3	±10	350
PG	NA	NA	NA	±10	NA

- Load change repetition rate: 50Hz to 10KHz,50%duty
- Load slew rate: 1A/us
- The audible noise level of the power supply shall not increase during transient loading.

Capacitors for dynamic Tests:

For cross and dynamic testing please refer to the sections above to see the max step load and max slew rate. During dynamic testing the output voltages will remain within their specified regulation tolerances.

Step load repetition rate: 50Hz - 10kHz,50% duty.

For dynamic tests connect below capacitors:

NOM. OUTPUT VOLTAGE (VDC)	CAPS	Impedance Z at 100KHz/25°C
5V	4700μF	NA
12V	2200μF	NA
3.3V	4700μF	NA
5Vsb	1000μF	NA
-12V	350μF	NA

2.5 Capacitive Loads

 <b>台達電子工業股份有限公司</b> <b>DELTA ELECTRONICS, INC.</b>				DESCRIPTION: 電氣規格 (Electrical Specification)	
				MODEL NO. <b>GPS-850LB A</b>	
THESE DRAWINGS AND SPECIFICATIONS ARE THE PROPERTY OF DELTA ELECTRONICS, INC. AND SHALL NOT BE REPRODUCED OR USED AS THE BASIS FOR THE MANUFACTURE OR SELL OF APPARATUSES OR DEVICES WITHOUT PERMISSION.				DOCUMENT NO. : <b>ES-850LB A</b>	
Date	Drawn	Design(EE)	Design(ME)	REV.	<b>S01</b>
08/26/'21	敖變鳳	董占強	宋廣		

The power supply should be able to power up and operate normally with the following capacitances simultaneously present on the DC outputs.

Output Capacitive Loads:

Output	Capacitive Loads( $\mu F$ )
+12VDC	10000 $\mu F$
+5VDC	10000 $\mu F$
+3.3VDC	10000 $\mu F$
-12VDC	350 $\mu F$
+5VSB	4700 $\mu F$

### 2.6 Loop Stability

The power supply shall be unconditionally stable while operating within its normal operating specification. The power supply shall maintain a minimum of 45 deg Phase margin and 10dB gain across valid load condition.

### 3. Timing:

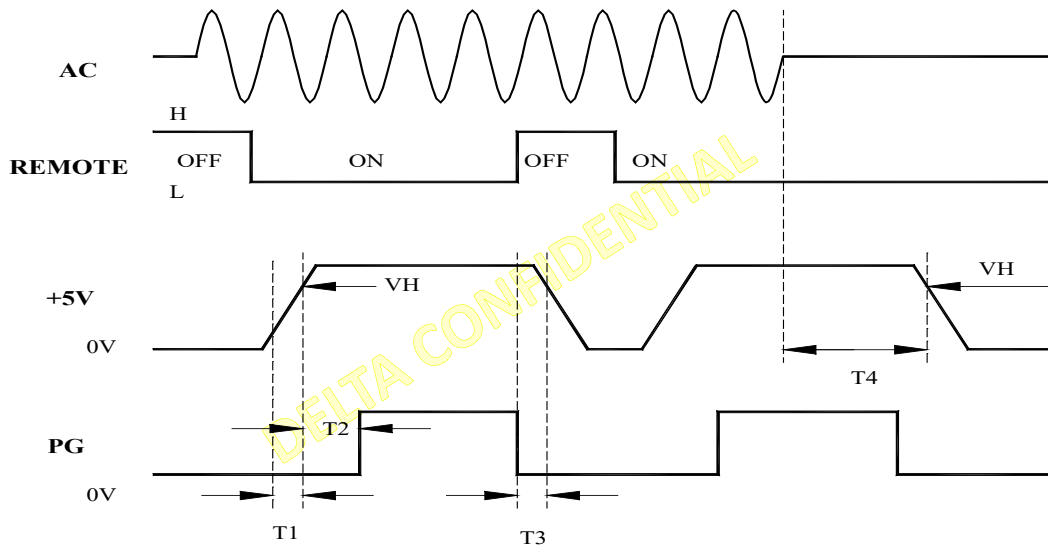

台達電子工業股份有限公司  
DELTA ELECTRONICS, INC.

DESCRIPTION:  
電氣規格 (Electrical Specification)

THESE DRAWINGS AND SPECIFICATIONS ARE THE PROPERTY OF DELTA ELECTRONICS, INC. AND SHALL NOT BE REPRODUCED OR USED AS THE BASIS FOR THE MANUFACTURE OR SELL OF APPARATUSES OR DEVICES WITHOUT PERMISSION.

MODEL NO.  
**GPS-850LB A**

Date	Drawn	Design(EE)	Design(ME)	DOCUMENT NO. :	REV.
08/26/'21	敖變鳳	董占強	宋廣	<b>ES-850LB A</b>	<b>S01</b>

Note:

- (1) T1: Rise time (0.2ms<T1<20ms).
- (2) T2: Power good signal turn on delay time (100ms<T2<500ms, 5V vs PG).
- (3) T3: Power good signal turn off delay time (T3 ≥ 1ms ;DC on/off, PG to 12V).
- (4) T4: Power hold-up time (T4 ≥ 15ms, 115Vac/60Hz input ,at 80% full load, respect to PG ).
- (5) **PS-ON Delay Time: 500mS max. at nominal line . PS-ON with respect to +5V.**
- (6) Rise Time: Any outputs rise time from 10% to 90% of normal voltage should be < 20 ms.

4. Protections:

- 4.1 Over Voltage Protection:** +5V, +5VSB output set at 5.5V~7.5V  
 +12V set at 13.2V~16.5V.  
 +3.3V set at 3.63V~5V maximum.

The power supply should shut down and latch off for +5V, +12V, +3.3V OVP triggered, for +5VSB OVP is clamping mode.

**4.2 Short Circuit Protection:**

The power supply shall shut down and latch off for shorting +5V,+12V, -12V or +3.3v rails to GND and shorting +5VSB to GND P/S can latch down or automatically recovery when the fault condition is removed. Short resistor need less than 0.03ohm.

- 4.3 Over Current Protection:** +5V:30A min to 55A max  
 +12V:75A min to 100A max;  
 +3.3V: 30A min to 55A max.  
 +5Vsb:3.5A min to 10A max

The power supply should shut down and latch off for +5V, +12V, -12V, +3.3V OCP triggered and for 5Vsb OCP PSU should automatically recovery when the fault condition is removed.

**4.4 No Load Operation: No Damage Or Hazardous Condition Will Occur.**

**4.5 Over Temperature Protection:**

The power supply shall automatically shut down and latch off in the event of a fan failure, an airflow failure, or any other abnormal condition that results in excessive temperatures within the

 <b>台達電子工業股份有限公司</b> <b>DELTA ELECTRONICS, INC.</b>				DESCRIPTION:	
				<b>電氣規格 (Electrical Specification)</b>	
THESE DRAWINGS AND SPECIFICATIONS ARE THE PROPERTY OF DELTA ELECTRONICS, INC. AND SHALL NOT BE REPRODUCED OR USED AS THE BASIS FOR THE MANUFACTURE OR SELL OF APPARATUSES OR DEVICES WITHOUT PERMISSION.				MODEL NO.	
				<b>GPS-850LB A</b>	
Date	Drawn	Design(EE)	Design(ME)	DOCUMENT NO. :	REV.
08/26/'21	敖夔鳳	董占強	宋廣	<b>ES-850LB A</b>	<b>S01</b>

power supply.

#### 4.7 Line Voltage Sag/Surge

Sag:

Test condition:  $V_{in}=110-80-110Vac, 230-161-230Vac$ ; SAG times :500ms;

load condition: 80% max load.

Requirement: No function loss

Surge:

Test condition:  $V_{in}=132-155-132Vac, 264-293-264Vac$ ; Surge times :500ms;

load condition: 80%maxload.

Requirement: No function loss.

#### 4.8. Drop out

Test condition:  $V_{in}=115-0-115Vac, 230-0-230Vac$ ; Drop time=15ms; load condition: 80%maxload.

Requirement: No function loss.

#### 4.9 Brownout/Brownout recovery

Brownout

100Vac to 0Vac@60Hz 80%max load.;Set Voltage decreasing step@3V/S from 100Vac as test start, and after finish the test period, the PSU shall have no any damage.

Brownout recovery

0Vac to 100Vac@60Hz 80%max load, Set Voltage increasing step@3V/S from 0V as test start and after finish the test period, the PSU shall have no any damage.

### 5. Dielectric Withstand Voltage:

#### 5.1 Dielectric Strength (HI-POT):

(a)Primary To Secondary: 2100Vac 1sec.

(b)Primary To F.G: 2100Vac 1sec.

(c) Voltage ramp time: 500 V/Second ramp Minimum

(d) Cut off current: 15mA Max.

**5.2 Insulation Resistance:** Primary To Safety Ground: 500Vdc, 5M $\Omega$  Min.

				台達電子工業股份有限公司 DELTA ELECTRONICS, INC.		DESCRIPTION: 電氣規格 (Electrical Specification)	
THESE DRAWINGS AND SPECIFICATIONS ARE THE PROPERTY OF DELTA ELECTRONICS, INC. AND SHALL NOT BE REPRODUCED OR USED AS THE BASIS FOR THE MANUFACTURE OR SELL OF APPARATUSES OR DEVICES WITHOUT PERMISSION.				MODEL NO. <b>GPS-850LB A</b>			
Date	Drawn	Design(EE)	Design(ME)	DOCUMENT NO. :		REV.	
08/26/'21	敖變鳳	董占強	宋廣	<b>ES-850LB A</b>		<b>S01</b>	



5.3 Ground continuity test: Less than 0.1ohm for 25A current

5.4 Leakage Current: Measured At 240Vac/50Hz and 2.5mA Max.

## 6. Conducted EMI: Internal Filter Can Meet

A. FCC PART 15J CLASS B

B. CISPR 22(EN55022) CLASS B

C Test condition 100% dummy load.

## 7. EMS

### 7.1 Electrostatic Discharge IEC 61000-4-2:

Contact Discharge: +/- 8KV

Air Discharge: +/-15KV

### 7.2 PLD: The power supply shall operate within specifications.

Surge Immunity IEC 61000-4-5:

Common Mode: +/-2KV

Difference Mode: +/-1KV

EFT IEC61000-4-4: +/-1KV

## 8. Safety requirement

8.1 CB

8.2 BSMI

8.3 TUV

8.4 CCC

8.5 CE

8.6 UL+CUL

8.7 CU, CU(ROHS)

8.8 FCC

8.9 KC, KCC

DELTA CONFIDENTIAL

				台達電子工業股份有限公司 DELTA ELECTRONICS, INC.		DESCRIPTION: 電氣規格 (Electrical Specification)	
THESE DRAWINGS AND SPECIFICATIONS ARE THE PROPERTY OF DELTA ELECTRONICS, INC. AND SHALL NOT BE REPRODUCED OR USED AS THE BASIS FOR THE MANUFACTURE OR SELL OF APPARATUSES OR DEVICES WITHOUT PERMISSION.				MODEL NO. <b>GPS-850LB A</b>			
Date	Drawn	Design(EE)	Design(ME)	DOCUMENT NO. :		REV.	
08/26/'21	敖變鳳	董占強	宋廣	<b>ES-850LB A</b>		<b>S01</b>	

## 9. Environment:

9.1 Operating Temperature: 0°C TO 50 °C (derating from 100% to 80% from 40° C to 50° C).

9.2 Operating Relative Humidity: 5% TO 85%.

9.3 Storage Temperature: -40 TO + 70 °C .

9.4 Storage Relative Humidity: 5% TO 95%.

9.5 Altitude: Operate Properly At Any Altitude Between 0 to 16404.2 Feet. Storage: 50,000 Feet

9.6 MECHANICAL SHOCK

9.7 Non-operating shock:

Half sine shock  
Duration 11ms by 50G acceleration  
Minimum 3 shocks on each of six faces.

9.8 Non-Operating Random Vibration:

0.015G<sup>2</sup>/Hz 5 to 100Hz  
-6dB/octave 100 to 137Hz  
0.008G<sup>2</sup>/Hz 137 to 350Hz  
-6dB/octave 350 to 500Hz  
0.0039<sup>2</sup>/Hz 500Hz  
2.09Grms 20 minutes/axis along all three axes.

## 10. Burn-IN:

Unit Shall Be Burn In Under 40°C ± 5°C, With 115Vac And Outputs At 80% Of Max. Load.

## 11. M.T.B.F:

100K Hours Min At Max. Load 115Vac, And 25°C Ambient Conditions.

				台達電子工業股份有限公司 DELTA ELECTRONICS, INC.		DESCRIPTION: 電氣規格 (Electrical Specification)	
THESE DRAWINGS AND SPECIFICATIONS ARE THE PROPERTY OF DELTA ELECTRONICS, INC. AND SHALL NOT BE REPRODUCED OR USED AS THE BASIS FOR THE MANUFACTURE OR SELL OF APPARATUSES OR DEVICES WITHOUT PERMISSION.				MODEL NO. <b>GPS-850LB A</b>			
Date	Drawn	Design(EE)	Design(ME)	DOCUMENT NO. :		REV.	
08/26/'21	敖變鳳	董占強	宋廣	<b>ES-850LB A</b>		<b>S01</b>	