



IKS-24S

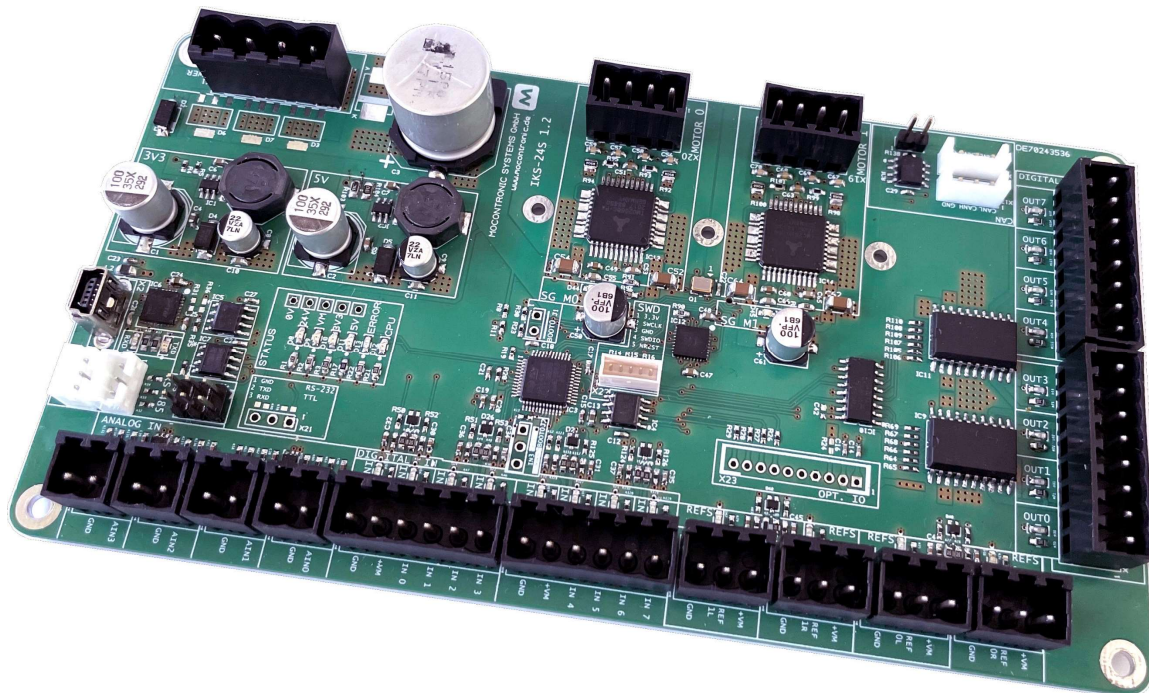

figure 1 IKS-24S

Product manual

For hardware version 1.2, firmware version IKS-24S_HW.V.1.2_1.00 and later

Name	Produkt handbook	Revision	05 / 15.12.2017
Nr.		Freigabe	AW
Legende		Seiten	1/27





Safety and warning notes

Before installing and operating the product, please read this product manual carefully and observe all warnings and safety instructions. Always keep this product manual within easy reach near the product.

Hinweise



WARNING

Failure to observe warnings may result in death, serious injury or considerable damage to property in extreme cases.



NOTE

Failure to observe notes may result in minor personal injury, damage to property due to heat generation or malfunction.

General precautions



WARNING

To avoid protection against electric shock, do not remove the cover of the housing. There is voltage inside the case which may cause electric shock. Have the unit used only by qualified personnel.



WARNING

- Installation, operation and maintenance of this product may only be performed by qualified personnel who are fully familiar with the operation of the control system.
- To prevent injury and damage, do not touch any components inside the housing - either with your hands or with any objects when voltage is present.
- Also exclude dust, dirt, flammable atmospheres and aggressive gases. The installation location should be a well-ventilated place not exposed to direct sunlight.
- Install the unit on a non-flammable wall that is as vertical as possible and transmits as little vibration as possible.
- Never disconnect the motor connection when the controller is live.
- Never apply voltage to inputs (motor, outputs) that are not designed for this purpose.
- Do not work on the wiring when voltage is applied.
- Make sure that the input voltage corresponds to that of the control.
- During proper use, the motor controls may heat up due to their design.
- Improper use, such as reversing the polarity of the supply voltage or overvoltage, may result in the formation of flames or even a fire. Injuries due to exploding components are also possible.

Name	Produkt Handbuch	Revision	05 / 15.12.2017
Nr.		Freigabe	AW
Legende		Seiten	2/27





NOTE

After delivery of the controller, make sure that there is no transport damage. Check whether the delivered goods correspond to the information on the delivery note and your order.



Intended use of the control unit

This product is not a household appliance, but an "unfinished machine" in the sense of the Machinery Directive 2006/42/EC, which is intended exclusively for further use for commercial purposes. This control unit is electrical equipment for controlling stepper motors and is intended for installation in machines or assembly with other components to form a machine.

Operation is prohibited until the operator has determined that the entire machine complies with the EMC Directive 2004/108/EC and EN 60204-1 on electrical equipment. The responsibility for compliance with the European Directives in the use of the machine lies with the subsequent user (Industrial Safety Regulation, Work Equipment Directive). This applies in particular to the risk assessment.

The technical data and descriptions in this operating manual have been compiled to the best of our knowledge and belief. No liability can be accepted for errors.



NOTE

Mocontronic considers the following standards during development and production: Low Voltage Directive 2006/95/EC, Machinery Directive 2006/42/EC, Product Safety Directive 2001/95/EC, EMC Directive 2004/108/EC, Product Liability Directive 85/374/EEC.

Name	Produkt Handbuch	Revision	05 / 15.12.2017
Nr.		Freigabe	AW
Legende		Seiten	3/27





Table of contents

Description and technical data.....	6
1.1 General Description	6
1.1.1 Technical data, maximum ratings	6
1.2 Dimensions	8
1.2.1 Mocontronic IKS-24S	8
1.3 Scope of supply	8
1.3.1 Optional parts.....	8
Overview of connections and their functions	9
Description of connectors	9
3.1 Power supply (X1)	9
3.1.1 motor control	10
3.1.2 motors, +24V power outputs, digital outputs.....	10
3.1.3 Power connection diagram.....	10
3.2 Communication ports.....	11
3.2.1 USB port (X2).....	11
3.2.2 RS-485 ports (X3, X4)	11
3.2.3 CAN ports (X17, X18)	12
3.3 Analog inputs (0...+10V) (X5, X6, X7, X8)	12
3.4 Digital +24V inputs (X9, X10).....	13
3.5 Reference switch inputs (X11, X12, X13, X14)	14
3.6 Digital +24V Outputs (X17, X18).....	14
3.7 Motor connectors (X19,X20)	15
3.8 Optional connectors.....	15
3.8.1 RS-232, 3.3V level (X24) – optional	15
3.8.2 SWD connector (X25)	15
3.8.3 Optional IO (X26).....	15
3.9 Status LED	16
3.10 Jumper	17
3.10.1 BOOT0 (J1) - optional.....	17
3.10.2 BOOT1 (J2) - optional.....	17
3.10.3 RS-485 (J3).....	17
3.10.4 CAN bus termination (J4)	18
Firmware/Software	19
4.1.1 Bootloader	19
4.2 TMCL-IDE	19
4.3 USB driver.....	19
4.4 module (serial) address and broadcast address.....	19
4.5 Mocontronic specific TMCL-Instructions	19

Name	Produktthandbuch	Revision	05 / 15.12.2017
Nr.		Freigabe	AW
Legende		Seiten	4/27





- 4.5.1 motor current setting..... 19
- 4.5.2 reading analog inputs 22
- 4.5.3 Polling digital inputs 22
- Hints for comissioning 23
- 5.1 Communication ports..... 23
 - 5.1.1 module (serial) address 23
 - 5.1.2 Baudrate..... 23
- FAQ - Answers 23
- Mounting 23
- 7.1 EMC compliant installation..... 23
- Risk accessment..... 24
- 8.1 Protection against electric shock 24
- 8.2 Protection against extreme temperatures 25
- 8.3 Protection against electromagnetic interference 25
- 8.4 Protection against mechanical hazards after installation in the customer product: ... 25
- Annex 1, point 1.2.3. starting up 25
- Annex 1, point 1.2.4. stopping..... 25
- Annex 1, point 1.2.5. selection of control or operating modes..... 25
- Annex 1, point 1.3. protective measures against mechanical hazards 25
- Annex 1, point 1.5.5 Extreme temperatures 25
- Annex 1, point 1.5.6 Fire 25
- Annex 1, point 1.7.2 Warning of residual risks 25
- Insulation of conductors 26
- Installation in housings..... 26
- Safety-conscious design of circuit diagrams..... 26
- Sensible arrangement of reclosing devices 26
- Overcurrent protection 26
- Protective grounding 26
- Maintenance and inspection 26
- Directories..... 26
 - 10.1 Directory of figures..... 26
 - 10.2 Directory of tables..... 26
- Revision History 27
 - 11.1 Document Revisions 27
 - 11.2 Hardware Revisions 27
 - 11.3 Firmware Revisions..... 27

Name	Produkt Handbuch	Revision	05 / 15.12.2017
Nr.		Freigabe	AW
Legende		Seiten	5/27





Description and technical data

1.1 General Description

The IKS-24S is a compact three axis stepper motor controller. The controller has a Trinamic TMCL compatible command set and is scriptable. Thus, the IKS-24S is designed for stand-alone and or host controlled operation.

Power supply:

- 1x +24V input for power supply of the controller.
- 1x +24V (+VM) input for the power supply of the motor output stages and the +24V outputs as well as the digital +24V switching outputs. This allows an emergency stop function to be implemented.

Communication:

- 1x USB-Mini B socket. A virtual COM port provides a serial RS-485 interface. This is used for communication with the IKS-24S. In addition, the RS-485 bus is routed to the outside via a 3-pin JST connector. This allows additional devices to be added to the RS-485 bus. The RS-485 bus has separately switchable bias resistors, as well as a bus termination.
- 1x CAN interface, with switchable terminating resistor.
- Inputs and Outputs:
- 4x 0-10V analog inputs, 12-bit resolution.
- 4x +24V level reference switch inputs. For each axis one right and one left.
- 4x +24V level outputs, Push-Pull, (2 Watts max.).

Motors:

- 2 connectors for bipolar stepper motors, 24V, 2.2 A_{rms}, 3.1 A_{Peak}.

1.1.1 Technical data, maximum ratings

table 1 technical data, maximum values

Symbol	Parameter	Min	Typ	Max	Unit
U _{+24V}	control supply voltage	20	24	26	V
U _{+VM}	Motor supply voltage und +24V level Inputs and Outputs. Note: The values for the +24V voltage outputs and the digital +24V outputs are defined by this voltage!		24	26	V
I _{in U_{+24V} Max.}	Control Current consumption (into U _{+24V})			0,1	A
I _{in UVM Max.}	Motor Current consumption (into U _{+VM})		$\ll 2 \times I_{Motor (peak)} + I_{max +24V digital outputs} + I_{+24V supply outputs}$	$1.4 \times 2 \times I_{Motor (peak)} + I_{max +24V digital outputs} + I_{+24V supply outputs}$	A
I _{+24 supply outputs}	Output current of the +24V supply outputs			0.1 ³⁾	A
P _{Pmax +24 supply outputs}	Maximum power of the digital outputs 0 through 3, and 4 through 7	0		4	W
I _{+24V supply outputs}	Output current of the digital +24V outputs			0.1 ³⁾	A
I _{+3,3V outputs}	Output current of the digital +3,3V outputs			0.005	A

Name	Produkt Handbuch	Revision	05 / 15.12.2017
Nr.		Freigabe	AW
Legende		Seiten	6/27





Symbol	Parameter	Min	Typ	Max	Unit
U _{+24V supply outputs}	Voltage of the +24V supply outputs			U _{+VM}	V
U _{+24V supply outputs}	Voltage of the +24V supply outputs			U _{+VM}	V
U _{+3,3V digital outputs}	Voltage of the digital +3,3V outputs		3.3		V
U _{Motor}	Motor voltage			U _{+VM}	V
I _{Motor (rms)}	Motor current (rms, root mean square)			2.2 ¹⁾ / 2.7 ²⁾	A
I _{Motor (peak)}	Motor current (peak)			3.1 ¹⁾ / 3.8 ²⁾	A
U _{in high digital inputs}	high level voltage für digital inputs	3.3			V
U _{in low digital inputs}	low level voltage für digital outputs			1.0	V
U _{in high reference switches}	high level voltage für reference switch inputs	3.3			V
U _{in Low reference switches}	Low level voltage für reference switch inputs			1.0	V
U _{Ain}	Voltage of the analog inputs	0		10	V
T _{Amb.}	Ambient temperature	0	25	30°	°C
	Relative humidity (important: no condensation!)	20		90	%
	Product life time due to electrolytic capacitors		2000		h
1) w/o heatsink. Only allowed at T _{amb.} of 25°C max. 2) with heatsink. Only allowed at T _{amb.} of 25°C. max. 3) Only allowed at T _{amb.} of 25°C. max.					

Name	Produktbandbuch	Revision	05 / 15.12.2017
Nr.		Freigabe	AW
Legende		Seiten	7/27





1.2 Dimensions

1.2.1 Mocontronic IKS-24S

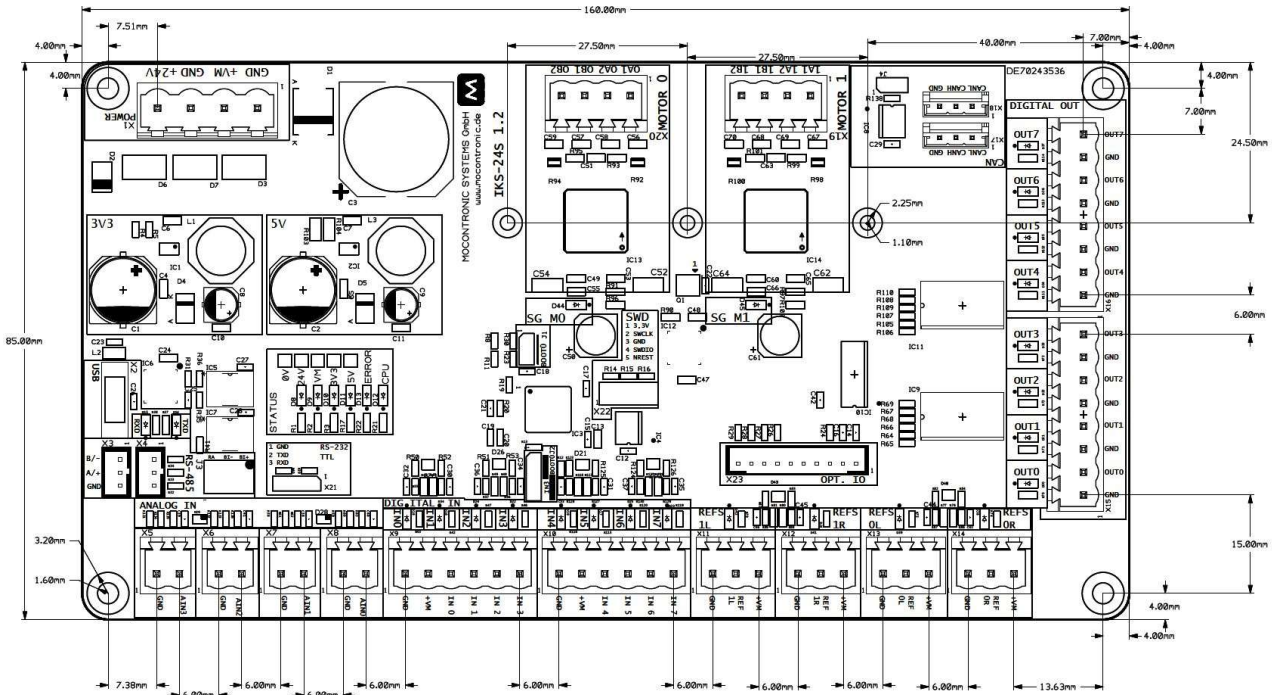

figure 2 dimensions

1.3 Scope of supply

Pos.	quantity	description
1	1	IKS-24S

table 2 scope of supply

1.3.1 Optional parts

table 3 optional parts

Option.	Beschreibung
1	Set of pluggable screw terminals für connectors X1, X5-X18, X21-X23.
2	2x, 3-wire, RS-485 cable for X3 und X4, 20cm long
3	2x, 3-wire., CAN cable X19 und X20, 20cm long
4	1x, mini USB-cable, 70cm long
5	Set of jumpers for RS-485 and CAN, (bias and termination)
6	Heat sink

Name	Produkt Handbuch	Revision	05 / 15.12.2017
Nr.		Freigabe	AW
Legende		Seiten	8/27





Overview of connections and their functions

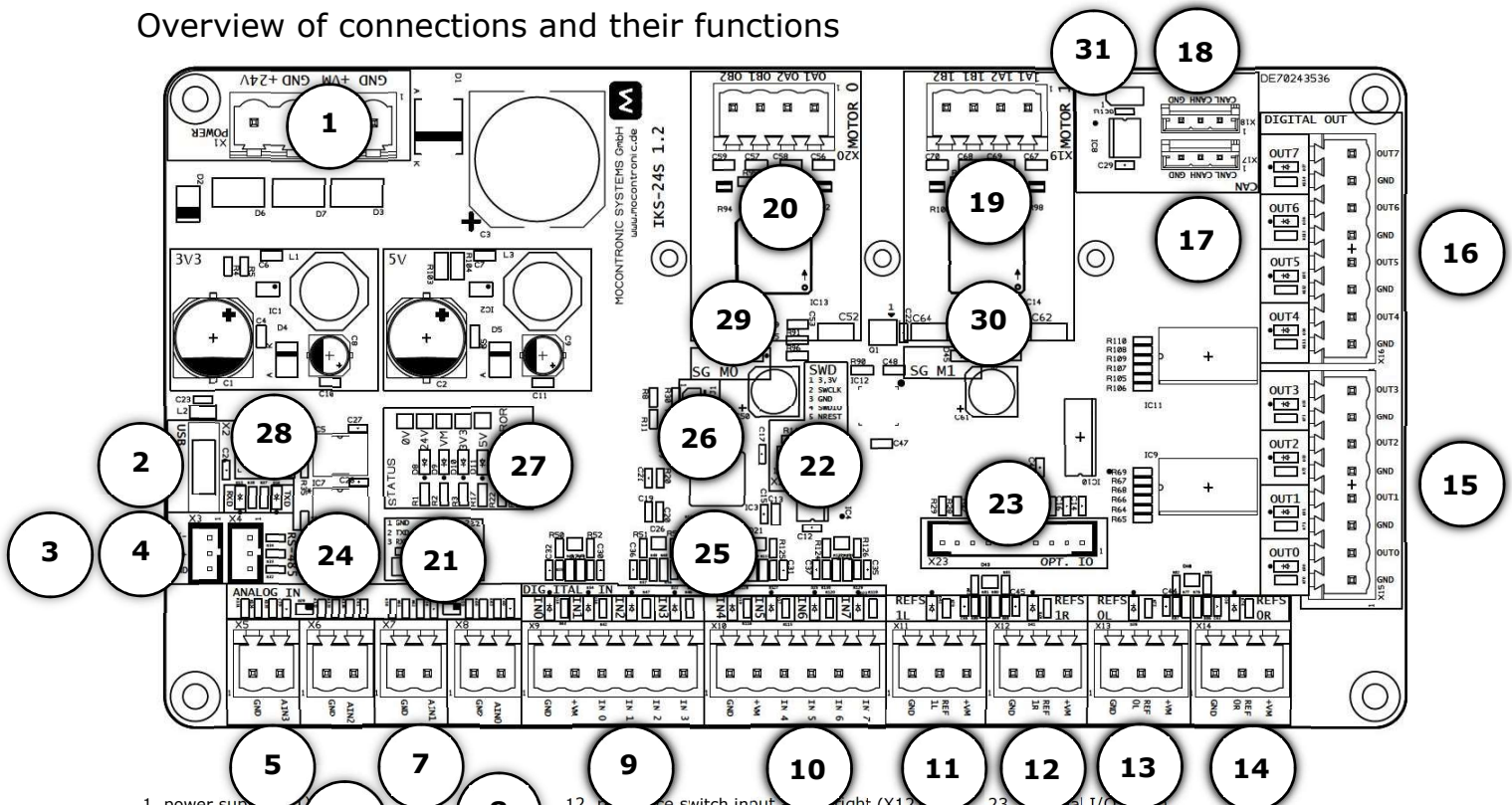

- | | | |
|--|---|----------------------------|
| 1. power supply (X1) | 12. reference switch input axis 0 right (X12) | 23. digital I/O (X23) |
| 2. USB (X2) | 13. reference switch input axis 0 left (X13) | 24. jumper RS-485 (J3) |
| 3. RS-485 (X3) | 14. reference switch input axis 0 right (X14) | 25. jumper, not used (J2) |
| 4. RS-485 (X4) | 15. digital +24V outputs OUT0-OUT3 (X15) | 26. jumper, not used (J1) |
| 5. analog input AIN3 (X5) | 16. digital +24V outputs OUT4-OUT7 (X16) | 27. status LED |
| 6. analog input AIN2 (X6) | 17. CAN connection (X17) | 28. USB LED, RxD and TxD |
| 7. analog input AIN1 (X7) | 18. CAN connection (X18) | 29. USB StallGuard motor 0 |
| 8. analog input AIN0 (X8) | 19. connection motor 1 (X19) | 30. USB StallGuard motor 0 |
| 9. digital +24V inputs IN0 to IN3 (X9) | 20. connection motor 0 (X20) | 31. jumper CAN |
| 10. digital +24V inputs IN4 to IN7 (X10) | 21. RS-232, TTL, optional (X21) | |
| 11. reference switch input axis 1 left (X11) | 22. SWD (X22) | |

figure 3 overview of connectors

Description of connectors

3.1 Power supply (X1)

The supply voltage is fed to the control unit via connection X1 marked with No. 1 in table 4. This connection allows the separate supply of the control as well as the supply for the motors, the +24V switching outputs and the +24V voltage outputs. This separation allows to switch off the motor voltage in case of danger without switching off the control.

Note!

- The wire size must be suitable for the maximum current consumption! EN 60 204-1 must be observed.
- Observe polarity and correct supply voltage! Failure to observe this may result in the formation of flames or even a fire. Injuries due to exploding components are also possible.

Name	Produkt Handbuch	Revision	05 / 15.12.2017
Nr.		Freigabe	AW
Legende		Seiten	9/27





table 4 power supply connector (X1)

	Pin	Bezeichnung	Beschreibung
	1	GND	GND, ground
	2	+VM	+24V power supply for motor, the +24V power outputs and +24V digital outputs.
	3	GND	GND, ground
	4	+24V	+24V controller supply.

3.1.1 motor control

The motor control of the IKS-24S requires a stabilized DC voltage of +24V. This is supplied to the control via pins 3 and 4 of the pluggable screw strip X1. See also figure 3 no. 1. An overview of the pin assignment is given in table 4. From this, the control generates the intermediate voltages of 3.3V and 5.0V required for the control logic. In the area of the status indicators, figure 3 no. 27. There are status LEDs for the voltages +24V, 3.3V and 5.0V.

3.1.2 motors, +24V power outputs, digital outputs

The motors, the +24V power outputs and the +24V digital outputs of the IKS-s4S require a stabilized DC supply voltage of +24V. This is supplied to the controller via pins 1 and 2 of the pluggable screw strip X1. See also figure 3 no. 1. An overview of the pin assignment is given in table 4. In the area of the status indicators, figure 3 No. 27. there is a status LED for the voltage +VM.

3.1.3 Power connection diagram

figure 4 shows the connection diagram for the power supply. The input for the power supply "+VM" can be connected via an emergency stop switch. In case of danger, the supply of the motors, the digital switching outputs and the +24V voltage outputs can be switched off safely this way. The controller indicates this state via the "Error LED".

The motors and the digital outputs are switched off if the voltage at input VM+ is below 15V for more than 50ms. Please note that no TMCL scripts can be processed in this mode!

If the voltage at VM+ is higher than 19V for more than 50ms, the motors, the digital outputs and the TMCL script processing are activated again!

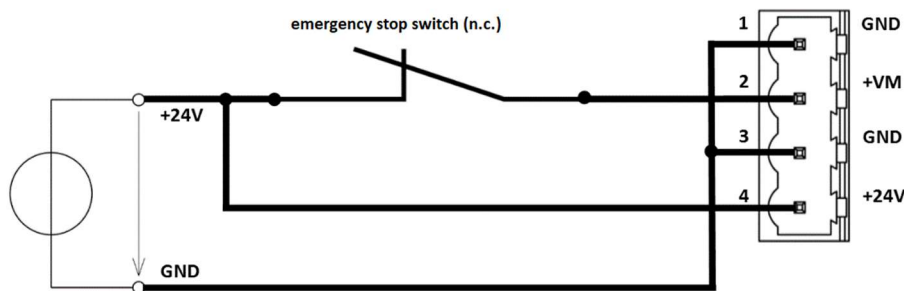

figure 4 power connection diagram

Name	Produkt Handbuch	Revision	05 / 15.12.2017
Nr.		Freigabe	AW
Legende		Seiten	10/27





3.2 Communication ports

The controller has a USB port. This provides a virtual serial RS-485 interface. This is used for communication with the motor controller. Further information about the USB to serial converter can be found in section 3.2.1 and 4.3. The additional external ports allow the connection of further devices to the RS-485 bus.

The controller also has a CAN communication port.

3.2.1 USB port (X2)

figure 3 no. 2. shows the mini USB B socket. See table 5 for the pin out.

table 5 USB port

	Pin	name	function
	1	+V Bus	+5V from USB host (PC)
	2	D-	USB data-
	3	D+	USB data+
	4	ID	n.c.
	5	GND	GND, ground

3.2.2 RS-485 ports (X3, X4)

figure 3 no. 3 and no. 4 show the RS-485 connections for additional devices. The X4 connector is optional. The RS-485 transceiver used is supplied with voltage by the USB host. Therefore it can be used even if the IKS-24S is not powered. An overview of the pinout is shown in table 6. In addition, two bias resistors and a 120Ω terminating resistor can be activated by jumper J3 (**Fehler! Verweisquelle konnte nicht gefunden werden.**, no. 24). The functions of jumper J3 are described in detail in chapter 3.10.3 and in table 16.

 **Hint!**

- Each bus participant (node) must have its own address.
- Shielded twisted pairs should be used
- The shielding should only be connected to ground at one point on the bus
- A terminating resistor of 120Ω should be installed at the master and at the last bus participant (node)
- The maximum cable length should not exceed 10m.

table 6 RS-485 ports (X3, X4)

	pin	name	function
	1	B/-	RS485 B. normally pin of a 2 of a 9-pin D-Sub connector
	2	A/+	RS485 A. normally pin of a 7 of a 9-pin D-Sub connector
	3	GND	GND, ground

figure 5 shows the schematic structure of the bias and the terminating resistor. For the +5V

Name	Produkt handbook	Revision	05 / 15.12.2017
Nr.		Freigabe	AW
Legende		Seiten	11/27



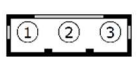

supply the USB voltage from the USB host is used.

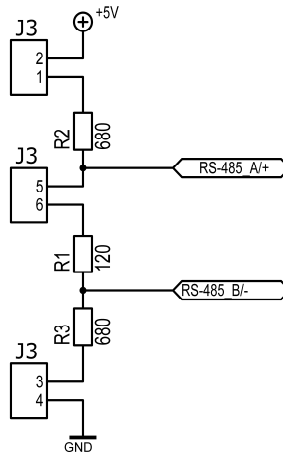

figure 5 RS-485 bias and termination

3.2.3 CAN ports (X17, X18)

figure 3 no. 17 and no. 18 show the CAN ports. An overview of the pinout is shown in table 7. A termination resistor of 120Ω can be activated by jumper J4 (figure 3, no. 31). The functions of jumper J4 are described in chapter 3.10.4 and in table 17 in detail.

Hint!

- Each bus participant (node) must have its own address.
- Shielded twisted pairs should be used
- The shielding should only be connected to ground at one point on the bus
- A terminating resistor of 120Ω should be installed at the master and at the last bus participant (node)
- The maximum cable length should not exceed 10m.

	pin	name	function
	1	CANL	CAN low normally pin of a 2 of a 9-pin D-Sub connector
	2	CANH	CAN high normally pin of a 7 of a 9-pin D-Sub connector
	3	GND	GND, ground

table 7 CAN ports (X17, X18)

3.3 Analog inputs (0...+10V) (X5, X6, X7, X8)

figure 3 no. 5 through 8 shows the analog inputs (0-10V). An overview of the pin out is shown in table 8. The inputs circuitry is shown in figure 6.

The integrated analog to digital converter (ADC) has a 12bit resolution with a step width of 2.46582mV per LSB.

Hint!

- correct polarity has to respected.
- the maximum input voltage must not be exceeded.

Name	Produkt Handbuch	Revision	05 / 15.12.2017
Nr.		Freigabe	AW
Legende		Seiten	12/27





table 8 analog inputs 0...+10V (X5, X6, X7, X8)

	pin	name	function
	1	GND	GND, ground
	2	AIN0 / AIN1	analog input 0-10V

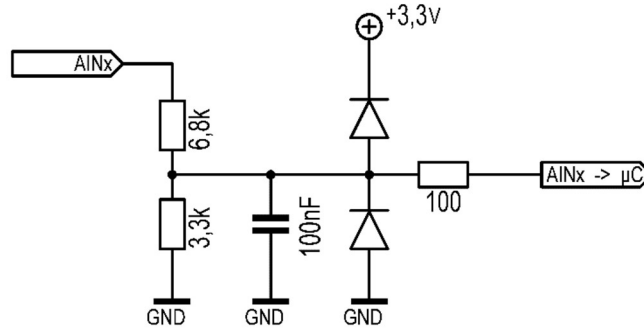

figure 6 analog input circuitry

3.4 Digital +24V inputs (X9, X10)

figure 3 no. 7 shows the digital +24V inputs. The pin out is listed in table 9. Every input line has an LED next to the input pin. The input circuitry is shown in figure 7.

Hint!

- correct polarity has to be respected.
- the maximum input voltage must not be exceeded.

table 9 digital +24V inputs (X9, X10)

	pin	name	function
	1	GND	GND, ground
	2	+VM	power output +VM (+24V)
	3	IN 0/4	digital +24V input no. 0/4
	4	IN 1/5	digital +24V input no. 1/5
	5	IN 2/6	digital +24V input no. 2/6
	6	IN 3/7	digital +24V input no. 3/7

Name	Produktanhandbuch	Revision	05 / 15.12.2017
Nr.		Freigabe	AW
Legende		Seiten	13/27



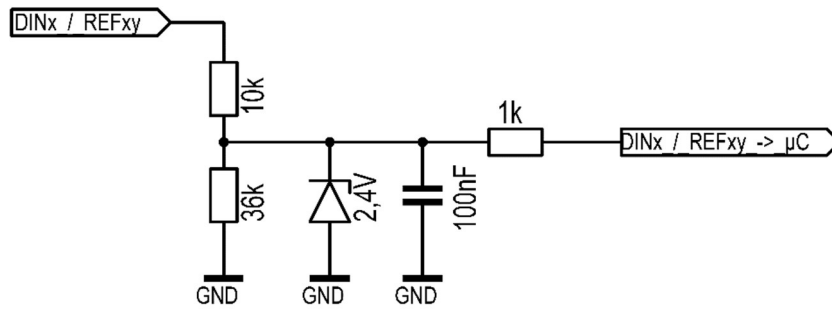

figure 7 circuitry of digital an reference switch inputs

3.5 Reference switch inputs (X11, X12, X13, X14)

figure 3 no. 11 through 14 show the reference switch inputs. Each axis has a left and a right switch input. They can be used for referencing and as a stop switch. An overview of the pin assignment is shown in table 10. For control purposes, there is a status LED for each input above the terminal connection. The input wiring corresponds to that of the digital inputs. This is shown schematically in figure 7.

Hint!

- correct polarity has to respected.
- the maximum input voltage must not be exceeded.

table 10 reference switch inputs (X11, X12, X13, X14, X15, X16)

	pin	name	function
	1	GND	GND, ground
	2	REF xy	referende switch input, +24V, x=0..1 (axis), y=R/L (right/left)
	3	+VM	power supply output +VM (+24V)

3.6 Digital +24V Outputs (X17, X18)

figure 3 no. 15 and 16 show the +24V digital outputs. The pin out is shown in table 11. For control purposes, there is a status LED for each output above the terminal connection.

Hint!

- correct polarity must be respected.
- the maximum output current must not be exceeded!
- the digital outputs are NOT protected against short circuits!
- the maximum output power of the digital outputs 0 through 7 is 4 Watts.

Name	Produktthandbuch	Revision	05 / 15.12.2017
Nr.		Freigabe	AW
Legende		Seiten	14/27





table 11 digital +24V outputs (X17, X18)

pin	name	function
1	GND	GND, ground
2	OUT0/4	output OUT0/4, voltage level +VM (+24V), I_{max} 0,1A, suitable for inductive loads, No short circuit protection! no freewheeling diode!
3	GND	GND, ground
4	OUT1/5	output OUT1/5, voltage level +VM (+24V), I_{max} 0,1A, suitable for inductive loads, No short circuit protection! no freewheeling diode!
5	GND	GND, ground
6	OUT2/6	output OUT2/6, voltage level +VM (+24V), I_{max} 0,1A, suitable for inductive loads, No short circuit protection! no freewheeling diode!
7	GND	GND, ground
8	OUT3/7	output OUT3/7, voltage level +VM (+24V), I_{max} 0,1A, suitable for inductive loads, No short circuit protection! no freewheeling diode!

3.7 Motor connectors (X19,X20)

The figure 3 no. 19, 20 show the motor connectors. The pin out is listed in table 12.

Hint!

- The wire gauge and current rating of connectors must be adapted to the peak value of the motor current which is 1.4 times the effective value.
- The cable length between the controller and stepper motor should be less than 3m. Longer motor cables lead to poorer EMC behavior.
- The motor cabling should be shielded! The shield should be connected to ground over a large area at the controller and at the motor.
- Only change the motor cabling when the power is off!

table 12 motor connector (X19,X20)

pin	name	function
1	0/1A1	motor phase A1
1	0/1A2	motor phase A2
1	0/1B1	motor phase B1
1	0/1B2	motor phase B2

3.8 Optional connectors

The following section describes the optional connections that are provided for special applications.

3.8.1 RS-232, 3.3V level (X24) – optional

In figure 3 no. 21 the optional 3,3V level RS-232 connector is shown.

3.8.2 SWD connector (X25)

The figure 3 no. 22 shows the SWD connector (manufacturer use only).

3.8.3 Optional IO (X26)

The figure 3 no. 23 shows the optional IO connector.

Name	Produkt Handbuch	Revision	05 / 15.12.2017
Nr.		Freigabe	AW
Legende		Seiten	15/27





3.9 Status LED

The IKS-24S has various LEDs that indicate the status of the controller.

table 13 Status LED

Pos	LED name	Position as shown in figure 3	colour	description
1	+VM	status field, Nr. 27	Green	The +24V voltage supply for the motors, the +24V voltage outputs as well as the +24V switching outputs is present. Remark: Makes no statement about the exact voltage value!
2	+24V		Green	The +24V voltage supply is available. Remark Makes no statement about the exact voltage value!
3	+3.3V		Green	The +3.3V auxiliary voltage is available. Remark Makes no statement about the exact voltage value!
4	Error		Red	Error display. In the normal state, the LED is off. When the +VM voltage drops below 15V, the LED is on continuously.
5	CPU		Green	Flashes with the frequency of 1 Hz. Indicates that the microcontroller is running. If the LED is not lit, the controller is in bootloader mode. Check the jumper settings in section 3.9. Or no firmware has been uploaded yet..
6	USB RxD	at the USB socket, no. 28	Yellow	Data from a host to the control via USB or RS-485 is being received.
7	USB TxD		Green	Data to a host from the control via USB or RS-485 is transmitted.
8	INx	above connector no. 9/10	Yellow	Shows activity of the +24V digital inputs. x=0..3.
9	REFxy	above connectors no 11 through. 14	Yellow	Shows activity of the reference switch inputs. x=0..1 (axis), y= R/L (right/left).
10	OUTx	above connector no. 15/16	Yellow	Shows activity of the +24V digital outputs. x=0..3.
11	SG M0	at no. 30	Red	When the Trinamic StallGuard2 detection detects that the motor is blocked, the red LED lights up. NOTE: This function requires parameterization!
12	SG M1	at no. 29	Red	When the Trinamic StallGuard2 detection detects that the motor is blocked, the red LED lights up. NOTE: This function requires parameterization!

Name	Produktbandbuch	Revision	05 / 15.12.2017
Nr.		Freigabe	AW
Legende		Seiten	16/27







3.10 Jumper

3.10.1 BOOT0 (J1) - optional

The figure 3 no. 26 shows jumper J1 which activates the bootloader mode. An overview of the functionality is shown in table 14.

table 14 Jumper J1 - Bootloader

pos.	jumper setting		Beschreibung
1		Boot: 1-2 open	normal operation
2		Boot: 1-2 connected	bootloader mode In this jumper position the IKS-24S is set into the bootloader mode after applying the operating voltage. This is used to load a new firmware.

3.10.2 BOOT1 (J2) - optional

In figure 3 no 25 jumper J2 is marked. In figure 8 the pin numbers are shown. This jumper is used to switch between boot mode and input IN3. An overview of the functionality of the jumper is shown in table 15.

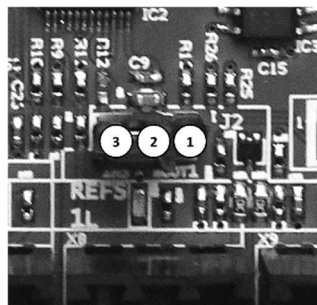



figure 8 Jumper J2 - Pin1

table 15 Jumper J2 – Bootloader / IN3

Pos	Jumper Stellung		Beschreibung
1		Boot: 1-2 connected	bootloader mode In this jumper position the IKS-24S is set into the bootloader mode after applying the operating voltage. This is used to load a new firmware.
2		IN3: 2-3 connected	normal operation. Input IN3 ist active.

3.10.3 RS-485 (J3)

In figure 3 no. 24 jumper J3 is marked. In figure 9 positions of the pins are shown. These jumpers can be used to activate two bias resistors and a 120Ω terminating resistor for the RS-485 serial interface. An overview of the functionality of the jumper is listed in table 16.

Name	Produkt Handbuch	Revision	05 / 15.12.2017
Nr.		Freigabe	AW
Legende		Seiten	17/27



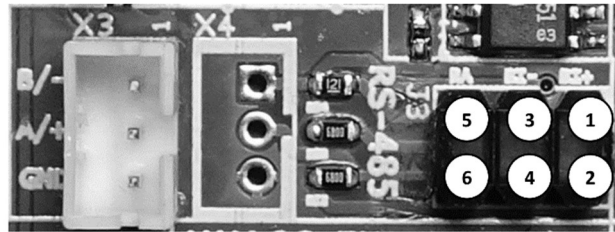

figure 9 Jumper J3 - Pin1

table 16 jumper J3 – RS-485

	Jumper	Jumper setting	Function
	1	pins 1 and 2 connected	activates a 680Ω bias resistor between RS-485 A/+ and +5V
		pins 1 and 2 open	deactivates a 680Ω bias resistor between RS-485 A/+ and +5V
	2	pins 3 and 4 connected	activates a 680Ω bias resistor between RS-485 B/- and ground
		pins 3 and 4 open	deactivates a 680Ω bias resistor between RS-485 B/- and ground
	3	pins 5 and 6 connected	activates the 120Ω termination resistor between RS-485 A/+ and RS-485 B/-
		pins 5 and 6 open	deactivates the 120Ω termination resistor between RS-485 A/+ and RS-485 B/-

3.10.4 CAN bus termination (J4)

In figure 3 no. 30 jumper J4 is marked. It activates the CAN bus termination resistor. An overview of the functionality of the jumper is listed in table 17.

table 17 Jumper J4 – CAN bus termination

Pos	Jumper setting		Function
1		1-2 open	120Ω termination resistor not active
2		1-2 connected	120Ω termination resistor active

Name	Produkt Handbuch	Revision	05 / 15.12.2017
Nr.		Freigabe	AW
Legende		Seiten	18/27





Firmware/Software

The functions of the IKS-24S are based on the TRINAMIC TMCM-1110 StepRocker controller. The Trinamic documentation of the TMCM-1110 can be used for commissioning. The documentation is available for download free of charge at http://www.mocontronic.de/wp-content/uploads/2015/07/TMCM-1110_TMCL_firmware_manual.pdf.

The current firmware version of the IKS-24S can be retrieved via command 136, type 0. The output data must be interpreted as ASCII characters. The output has the following format: 1110V100, which means module TMCM-1110, with FW version 1.00.

This designation of the module is not correct. But with this designation the TMCL IDE can be used without problems.

4.1.1 Bootloader

The IKS-24S is delivered with a bootloader, which allows to update the firmware!

4.2 TMCL-IDE

TRINAMIC TMCL-IDE and TMCL-PC are free programs for evaluation and development of own sequence programs. They also support the TRINAMIC Motion Control Language (TMCL) and are therefore ideally suited for the initial commissioning of the IKS-24S.

The software is available for free download here:

- <http://www.mocontronic.de/produkt/tmcl-ide-pc-programm-zur-steuerung-und-programmierung/>
- <https://www.trinamic.com/support/software/>

4.3 USB driver

The controller uses the FTDI (Future Technology Devices International Limited) IC FT232RQ. Current operating systems already have a suitable USB driver. If the operating system you are using does not include a driver, a corresponding driver is available for download from the FTDI website:

- <http://www.ftdichip.com/Drivers/VCP.htm>

4.4 module (serial) address and broadcast address

 **Hint!**

- the default module address is 1 and the default reply address is 2
- the default baud rate is 9600

The default module address is 1 and the default reply address is 2. Any other address can be assigned via global parameter 66 (SGP 66). Please note that the Reply address must not be used.

4.5 Mocontronic specific TMCL-Instructions

The extended functionality of the IKS-24S requires a few Mocontronic specific TMCL commands which are listed below.

4.5.1 motor current setting

Name	Produkt handbuch	Revision	05 / 15.12.2017
Nr.		Freigabe	AW
Legende		Seiten	19/27





! WARNING

- The maximum motor current is only permissible at an ambient temperature Tamb. of 25°C.
- Values that are too high can damage the motor!
- For currents above level 21, or Ipeak[A] greater than 3.2A, it is essential that a heat sink is present!

! Hint!

- by default, the motor current is limited to 2.2ARMS!

The current setting for drive and standby current of the output stages is set via SAP (Set Axis Parameter) parameters 6 and 7. A detailed description of the parameters can be found in table 18. Formula 1 and formula 2 can be used to calculate the current or the corresponding parameter.

$$I_{RMS}[A] = \frac{Parameter * 3,22[A]}{255}$$

formula 1 calculation of I_{rms}

$$Parameter = \frac{I_{RMS}[A] * 255}{3,22[A]}$$

formula 2 calculation of current paramters

It should be noted that in the standard version the current is limited to 2.2ARMS. This corresponds to a parameter value of 176. If higher values are entered, they are limited to 176. It should also be noted that the current can only be set in certain steps. An overview of the current stages can be found intable 19.

In the maximum expansion stage, a current of 2.78ARMS can be set. This corresponds to a parameter value of 208.

For currents above level 21 (parameter value greater than 176), it is mandatory to use a heat sink! It must also be noted that the maximum motor current is only permissible at an ambient temperature Tamb. of 25°C.

Via the axis parameter 208, the error flags of the output stages can be called up. These include flags for an overtemperature prewarning and an overtemperature situation.

Parameter values greater than 27 are not permitted. These can damage the output stages! This is prevented by the firmware.

table 18 adjusting current parameters

Instructi on SAP (5) / GAP (6)	Function	Type	Motor/ Bank	Value	R/W
	Maximum current. The absolute maximum current while the motor is moving. NOTE: Values that are too high can damage the motor!	6	0..1	0...208	R/W
	Standby current. Quiescent current or holding current when the motor is at a standstill.	7	0..1	0...208	R/W

Name	Produkt handbuch	Revision	05 / 15.12.2017
Nr.		Freigabe	AW
Legende		Seiten	20/27





table 19 current levels

Stufe	I _{RMS} [A]		I _{Peak} [A]	SAP 6 / 7		Bemerkung
				Min	Max	
0	0.101		0.142	0	8	
1	0.201		0.285	8	16	
2	0.302		0.427	16	24	
3	0.403		0.570	24	32	
4	0.504		0.712	32	40	
5	0.604		0.855	40	48	
6	0.705		0.997	48	56	
7	0.806		1.140	56	64	
8	0.907		1.282	64	72	
9	1.007		1.425	72	80	
10	1.108		1.567	80	88	
11	1.209		1.710	88	96	
12	1.310		1.852	96	104	
13	1.410		1.994	104	112	
14	1.511		2.137	112	120	
15	1.612		2.279	120	128	
16	1.713		2.422	128	136	
17	1.813		2.564	136	144	
18	1.914		2.707	144	152	
19	2.015		2.849	152	160	
20	2.115		2.992	160	168	
21	2.216		3.134	168	176	
22	2.317		3.277	176	184	Heatsink required!
23	2.418		3.419	184	192	Heatsink required!
24	2.518		3.562	192	200	Heatsink required!
25	2.619		3.704	200	208	Heatsink required!
26	2.720		3.847	208	216	Heatsink required!
27	2.821		3.989	216	224	not allowed!
28	2.921		4.131	224	232	not allowed!
29	3.022		4.274	232	240	not allowed!
30	3.123		4.416	240	248	not allowed!
31	3.224		4.559	248	254	not allowed!

Name	Produkt Handbuch	Revision	05 / 15.12.2017
Nr.		Freigabe	AW
Legende		Seiten	21/27





4.5.2 reading analog inputs

The analog inputs can be queried with the command GIO (15, Get Input Output). A detailed description can be found in table 20.

table 20 reading analog inputs

Instruction GIO (15)	Function	Type	Motor/ Bank	Value	R/W
	reading analog inputs.	0: external input AIN0 (0-10V) 1: external input AIN1 (0-10V) 2: external input AIN0 (0-10V) 3: external input AIN1 (0-10V) 4: internal input +3,3V 5: internal input +24V 6: internal input +VM 7: CPU-temperature in °C Hints: For the analog inputs IN0 and IN1, the voltage divider (6.8kΩ / 3.3 kΩ) for the 12bit analog-to-digital converter results in the following conversion factor: 2.46582 mV per counter. See also chapter 0. Example: A counter of 2395 corresponds to a voltage of 5.9056V. For the internal voltage dividers for the voltages 3.3V, +24V and +VM the conversion factor is: 0.008862 V / counter. Example: A counter of 2679 corresponds to a voltage of 23.741V. The CPU temperature is output directly.	1: analog	0...4096	R

4.5.3 Polling digital inputs

Polling of the digital inputs works just like on the Trinamic standard products, but only four inputs are available.

table 21 requesting digital inputs

Befehl GIO (15)	Function	Type	Motor/ Bank	Value	R/W
	requesting digital inputs.	0: general purpose input 0 1: general purpose input 1 2: general purpose input 2 3: general purpose input 3 4: general purpose input 4 5: general purpose input 5 6: general purpose input 6 7: general purpose input 7	0: digital	0...1 0: no/low signal. 1: high signal.	R

Name	Produktthandbuch	Revision	05 / 15.12.2017
Nr.		Freigabe	AW
Legende		Seiten	22/27





Hints for comissioning

5.1 Communication ports

We recommend to use the TRINAMIC TMCL-IDE for the initial commissioning of the controller (see also chapter 4.2). Further information can be found on these websites:

- <http://www.mocontronic.de>
- <https://www.trinamic.com/support/software/>

5.1.1 module (serial) address

The default module address is 1 and the default reply address is 2.

5.1.2 Baudrate

The default Baudrate is 9600 Baud.

FAQ - Answers

- The IC7 at the digital outputs heats up during normal operation. When the outputs are switched off, the temperature can be around 40°C.
- If the digital input IN3 is always read out as 1 "high" via the software, the jumper J2 should be checked. This must be in position IN3.
- If not all parameters can be set with the TMCL IDE 3.0, the TMCL IDE 2.17 can be used.
- The TMCL script processing is stopped if the voltage VM+ is below 15V!

Mounting

The control unit is an incomplete machine in the sense of the Machinery Directive 2006/42/EC, which requires installation in a housing or control cabinet, preferably made of metal.

Environmental influences such as high temperatures, high humidity, condensation must be prevented. Dust, dirt, flammable atmospheres and aggressive gases must also be excluded. The place of installation should be a well ventilated place, not exposed to direct sunlight. Install the device on a non-flammable, vertical wall that does not transmit vibrations.

When mounting, be aware that the control unit generates heat. For this reason, mount the controller vertically and make sure that the installation location is well ventilated to ensure adequate heat convection.

7.1 EMC compliant installation

Installation instructions:

- Mounting the controller in a grounded metal enclosure.
- Ground the controller at the connections provided for this purpose.
- Shielded motor cable; shield coverage $\geq 85\%$; apply shield on both sides and over a large area
- Separate the control lines from the mains, power supply and motor lines; if unavoidable, make crossings of control and motor lines at right angles.
- The cable length between control and stepper motor should be less than 3m. Longer motor cables lead to worse EMC behavior.
- During installation, ensure that the RF impedance between the controller and ground is as

Name	Produkt Handbuch	Revision	05 / 15.12.2017
Nr.		Freigabe	AW
Legende		Seiten	23/27





small as possible.

- Ensure that the metallic connections are as large as possible.
- Conductor loops act like antennas. Especially if they are spatially extended.
- Avoid unnecessary conductor loops.
- Avoid parallel routing of "clean" and interfering cables.
- Lay the motor cable and all analog and digital control and regulation lines shielded.
- You should leave the effective shielding area of these cables as large as possible, i.e. do not place the shield further than absolutely necessary.
- The shield must be connected to ground on both sides over a large area; if necessary, note exceptions for control lines in branched systems.
- A large-surface contacting can be realized by metallic cable glands or metallic mounting clamps.
- Use only copper braided cable (CY) with a coverage of 85%.
- The shielding should not be interrupted over the entire cable length. If, for example, the use of chokes or clamps is required in the motor cable, the unshielded part should be kept as short as possible.
- Very often interference is coupled in via the installation cables. You can minimize this influence.
- Lay interfering cables separately - minimum distance 0.25m - from interference-sensitive cables. The parallel laying of cables over longer distances is particularly critical. If two cables cross each other, the interference is smallest if the crossing is at an angle of 90 degrees.

Risk assessment

Mocontronic motor controllers can potentially pose hazards due to electric shock, high temperatures and electromagnetic interference. When using electric motors, there are also possible mechanical hazards.

Due to the overall low amounts of energy absorbed at also low extra-low voltages, the risks are assessed as low, provided that the following protective measures are followed:

8.1 Protection against electric shock

All controllers are operated with extra-low voltage according to IEC 60449, therefore, according to DIN VDE0100-410, protection against accidental contact is only required from 60 volts DC, unless "normal, dry environment" is to be assumed. We recommend contact protection from 48 volts for operation in dry rooms.

All controllers are designed for installation in an earthed metal housing which ensures a protection class appropriate to the environment in accordance with DIN VDE 0470-1.

In case Mocontronic delivers unfinished machines which are operated on mains voltage, they are installed in an appropriate housing. To avoid protection against electric shock do not remove the cover of the housing. There is voltage inside the housing which can cause an electric shock. Have the device used only by qualified personnel. As a protective measure, a residual current circuit breaker (RCCB) must be used in the supply line. According to VDE 0100 410, a residual current circuit breaker with a cut-off current $\leq 30\text{mA}$ and a cut-off time $\leq 0.3\text{s}$ must be used. In addition, a miniature circuit breaker of 16A must be used. Failure to observe these instructions may result

Name	Produkt Handbuch	Revision	05 / 15.12.2017
Nr.		Freigabe	AW
Legende		Seiten	24/27





in death, serious physical injury or considerable damage to property. The power supplies used by Mocontronic and their mounting comply with SELV construction according to DIN EN / UL 90750-1. This ensures a safe separation of mains and secondary protective extra-low voltage.

8.2 Protection against extreme temperatures

Motor controllers generate waste heat due to their design, the safe dissipation of which must be checked after installation in the customer's system. The use of fans may be necessary.

In addition, provision must be made for suitable automatic shutdown of the supply voltage and/or limitation of the operating current so that no overheating of touchable parts can occur even in the event of a fault. This also applies to connected cables, whose appropriate conductor cross-sections must be taken into account. EN 60 204-1 and VDE 0298-4 must be observed.

Improper use, such as reversing the polarity of the supply voltage or overvoltage, may result in the formation of flames or even a fire. Injuries due to exploding components are also possible.

In case Mocontronic delivers unfinished machines which are operated at mains voltage, they are installed in an appropriate housing. For protection against fire and danger of burns, a current limiter and a thermal switch are provided. In addition, a residual current circuit breaker (RCCB $\leq 30\text{mA}$, $\leq 0.3\text{s}$) and circuit breakers of 16A must be used.

8.3 Protection against electromagnetic interference

If power supplies with a final interference filter are used, the control unit is installed in a grounded metal housing and shielded cables are used, the basic EMC requirements are usually met. However, since the EMC behavior depends to a large extent on the design and location of the overall machine, the customer must test in accordance with the relevant environmental standard EN 55011, the product standard EN 61800-3 and the "mains standard" EN 61000-3-12.

8.4 Protection against mechanical hazards after installation in the customer product:

Due to the installation of motor controls and motors, the following points of the Machinery Directive must be observed in particular:

- Annex 1, point 1.2.3. starting up
- Annex 1, point 1.2.4. stopping
- Annex 1, point 1.2.5. selection of control or operating modes
- Annex 1, point 1.3. protective measures against mechanical hazards
- Annex 1, point 1.5.5 Extreme temperatures
- Annex 1, point 1.5.6 Fire
- Annex 1, point 1.7.2 Warning of residual risks

We recommend that the safety distances according to EN ISO 13857 for moving parts be taken into account as early as possible in the design process. Furthermore, we point out that both stepper and BLDC motors have only a very low holding torque when de-energized. A mechanical brake is therefore required for safe stopping, especially for larger moving masses. The STO (safe torque off) safety function can only be achieved by switching off the supply.

For the individually required protection and safety measures, the standard EN ISO 12 100 "Safety

Name	Produkt Handbuch	Revision	05 / 15.12.2017
Nr.		Freigabe	AW
Legende		Seiten	25/27





of machinery" should be taken into account, for example.

For electrical installation, EN 60204 (electrical equipment of machines), listed as a B standard in the Machinery Directive, should be observed, in particular the protective measures described there:

- Insulation of conductors
- Installation in housings
- Safety-conscious design of circuit diagrams
- Sensible arrangement of reclosing devices
- Overcurrent protection
- Protective grounding

Maintenance and inspection

In principle, no complex maintenance or inspection work is required on the motor control units. We recommend checking the following points at appropriate intervals:

- Cleaning the motor control unit of impurities such as dust and dirt.
- Checking the ventilation. Such as clear ventilation slots, functional fans, and clear air filters.
- Checking cable connections for secure connection.

Directories

10.1 Directory of figures

figure 1 IKS-24S	1
figure 2 dimensions	8
figure 3 overview of connectors.....	9
figure 4 power connection diagram	10
figure 5 RS-485 bias and termination.....	12
figure 6 analog input circuitry	13
figure 7 circuitry of digital an reference switch inputs.....	14
figure 8 Jumper J2 - Pin1.....	17
figure 9 Jumper J3 - Pin1.....	18

10.2 Directory of tables

table 1 technical data, maximum values.....	6
table 2 scope of supply	8
table 3 optional parts	8
table 4 power supply connector (X1).....	10
table 5 USB port.....	11
table 6 RS-485 ports (X3, X4).....	11

Name	Produkt-handbuch	Revision	05 / 15.12.2017
Nr.		Freigabe	AW
Legende		Seiten	26/27





table 7 CAN ports (X17, X18).....	12
table 8 analog inputs 0...+10V (X5, X6, X7, X8).....	13
table 9 digital +24V inputs (X9, X10).....	13
table 10 reference switch inputs (X11, X12, X13, X14, X15, X16).....	14
table 11 digital +24V outputs (X17, X18).....	15
table 12 motor connector (X21, X22, X23).....	15
table 13 Status LED.....	16
table 14 Jumper J1 - Bootloader.....	17
table 15 Jumper J2 - Bootloader / IN3.....	17
table 16 jumper J3 - RS-485.....	18
table 17 Jumper J4 - CAN bus termination.....	18
table 18 adjusting current parameters.....	20
table 19 current levels.....	21
table 20 reading analog inputs.....	22
table 21 requesting digital inputs.....	22
table 22 document revisions.....	27
table 23 Hardware Revisions.....	27
table 24 Firmware Revisions.....	27

Revision History

11.1 Document Revisions

table 22 document revisions

Version	Date	Author	Description
1.000	24.09.2021	CR	first draft
1.01	Oct 10th, 2021	AS	minor corrections

11.2 Hardware Revisions

table 23 Hardware Revisions

Version	Date	Author	Description
1.2	24.09.2021	CR	first prototype

11.3 Firmware Revisions

table 24 Firmware Revisions

Version	Datum	Autor	Description
1.2	24.09.2021	CR	first version

Name	Produktthandbuch	Revision	05 / 15.12.2017
Nr.		Freigabe	AW
Legende		Seiten	27/27

