

TMCS-28 Hardware Manual

Hardware Version V1.00 | Document Revision V1.60 • 2020-AUG-10

TMCS-28 is a low-cost and small-size optical incremental encoder for use with stepper motors and 3-phase PMSM/BLDC motors. It comes with high resolution optical code wheels with a resolution of up to 625 lines (40.000 counts).

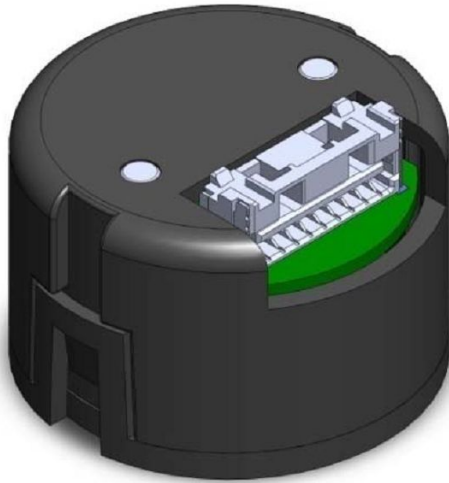

Features

- Low Cost
- High Resolution
- Small Dimension
- Easy Mounting

Applications

- Stepper Motor FOC
- Servo Motors
- Precision Motion Control
- Automated Equipment
- Robotics

Simplified Block Diagram

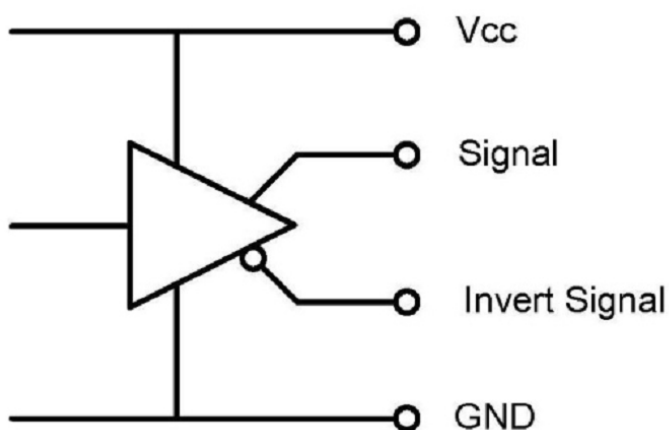

Contents

1 Order Codes	3
2 Technical Specifications	4
2.1 Mechanical and Electrical Parameters	4
2.2 Signals and Connection	6
2.3 Wave Form	7
2.4 Mechanical Drawings	8
2.5 Motor Assembly	9
3 Figures Index	10
4 Tables Index	11
5 Supplemental Directives	12
5.1 Producer Information	12
5.2 Copyright	12
5.3 Trademark Designations and Symbols	12
5.4 Target User	12
5.5 Disclaimer: Life Support Systems	12
5.6 Disclaimer: Intended Use	12
5.7 Collateral Documents & Tools	13
6 Revision History	14
6.1 Hardware Revision	14
6.2 Document Revision	14



1 Order Codes

Order Code	Description	Size (LxWxH)
TMCS-28-5-10000-AT-01	Encoder Module 28mm diameter, Resolution of 625lpr (40.000cpr), ABN, 5mm shaft diameter, TTL	28mm x 28mm x 18mm
TMCS-28-6.35-10000-AT-01	Encoder Module 28mm diameter, Resolution of 625lpr (40.000cpr), ABN, 6.35mm shaft diameter, TTL	28mm x 28mm x 18mm
TMCS-28-5-1024-AT-01	Encoder Module 28mm diameter, Resolution of 64lpr (4.096cpr), ABN, 5mm shaft diameter, TTL	28mm x 28mm x 18mm
TMCS-28-6.35-1024-AT-01	Encoder Module 28mm diameter, Resolution of 64lpr (4.096cpr), ABN, 6.35mm shaft diameter, TTL	28mm x 28mm x 18mm
TMCS-28-KIT	TRINAMIC TMCS-28 encoder kit including encoder housing, 1x TMCS-28-5-10000-AT-01, 1x TMCS-28-6.35-10000-AT-01, cable loom and assembly tools	100mm x 150mm x 30mm
TMCS-28-1024-KIT	TRINAMIC TMCS-28 encoder kit including encoder housing, 1x TMCS-28-5-1024-AT-01, 1x TMCS-28-6.35-1024-AT-01, cable loom and assembly tools	100mm x 150mm x 30mm

Table 1: Order codes

Other encoder resolutions, signal output types, and shaft diameters on request.



2 Technical Specifications

2.1 Mechanical and Electrical Parameters

Parameter	Min	Typ	Max	Unit
Supply voltage	4.5	5	5.5	V
Supply current			110	mA
Rise/fall time			10	ns
Frequency			1500	kHz
Output Voltage "H"	2.4			V
Input Voltage "L"			0.4	V
Max. output current			20	mA
Resolution (TMCS-28-x-10000-AT-01)		625		lpr (lines per rotation)
Resolution (TMCS-28-x-10000-AT-01)		40.000		cpr (increments per rotation)
Resolution (TMCS-28-x-1024-AT-01)		64		lpr (lines per rotation)
Resolution (TMCS-28-x-1024-AT-01)		4.096		increments (increments per rotation)

Table 2: Electrical Characteristics

Parameter	Min	Typ	Max	Unit
Hollow Diameter (symbol D in drawings)		5 / 6.35		mm
Shaft Loading Axial			50	N
Shaft Loading Radial			80	N
Max. RPM			6000	rpm
Net weight		30		g

Table 3: Mechanical Specifications



Parameter	Description
Operating Temperature	-20 – +85°C
Storage Temperature	-20 – +85°C
Operating Humidity	RH 85% max, non collecting
Shock	490 m/s^2 , 3Dx2 times
Vibration	1.2mm, 10-55kHz, 3Dx30min
Protection	IP40

Table 4: Environmental Specifications



2.2 Signals and Connection

Pin Number	Color	Signal Name
1	Red	VCC
2	Black	GND
3	White	A+
4	White/Black	A-
5	Green	B+
6	Green/Black	B-
7	Yellow	Z+
8	Yellow/Black	Z-
9	Blue	Shield

Table 5: Connector and cable pinning and signals

The required encoder cable connector is a Molex type 5023800900 CLIK-MATE™ crimp housing using Molex type 5023810000 CLIK-MATE™ crimp terminals.

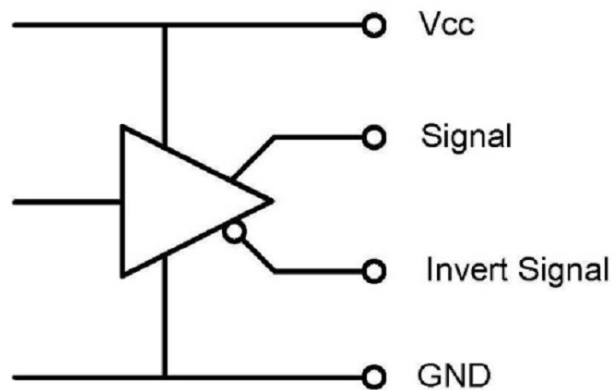

Figure 1: Connection and circuit diagram for the line driver outputs



2.3 Wave Form

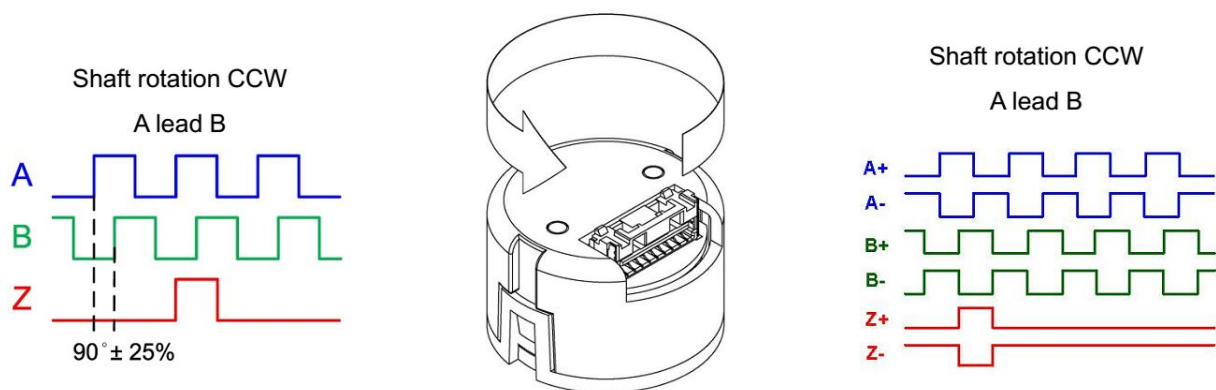

Figure 2: Example wave form for CCW rotation



2.4 Mechanical Drawings

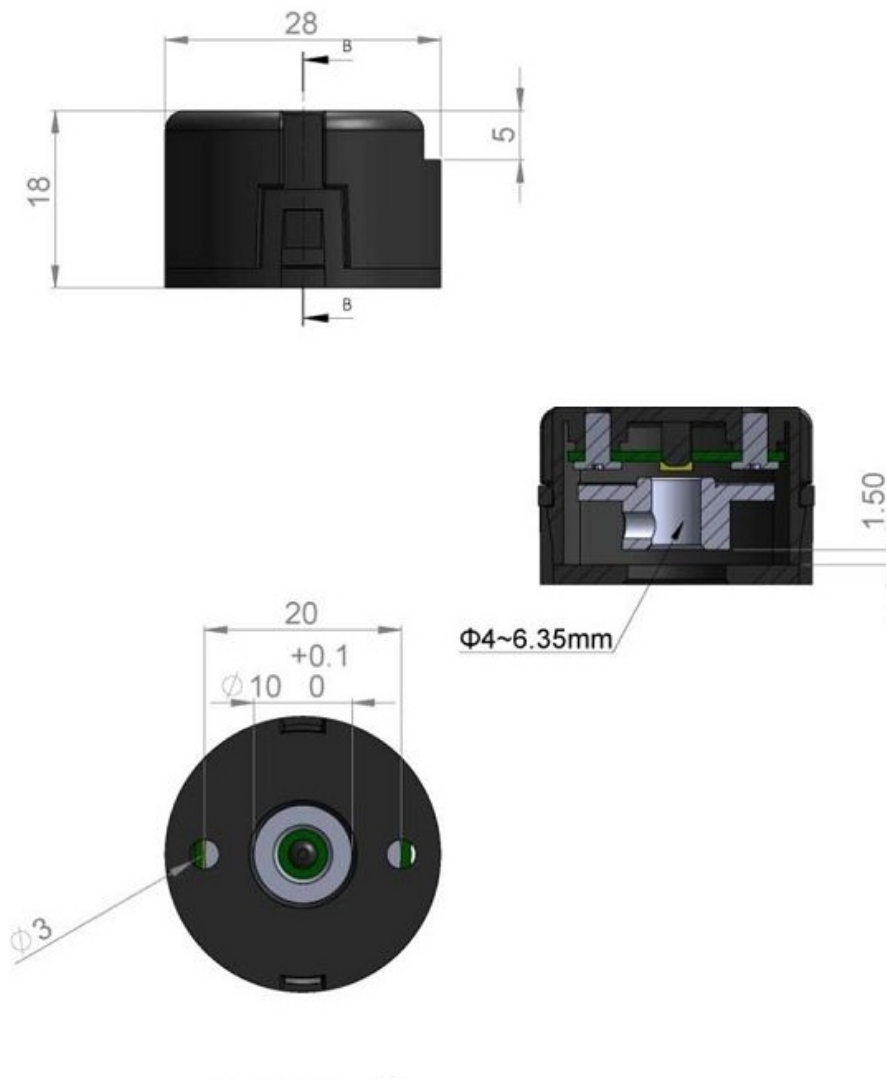

Figure 3: Bottom view, side view, and cut view (units = mm)



2.5 Motor Assembly

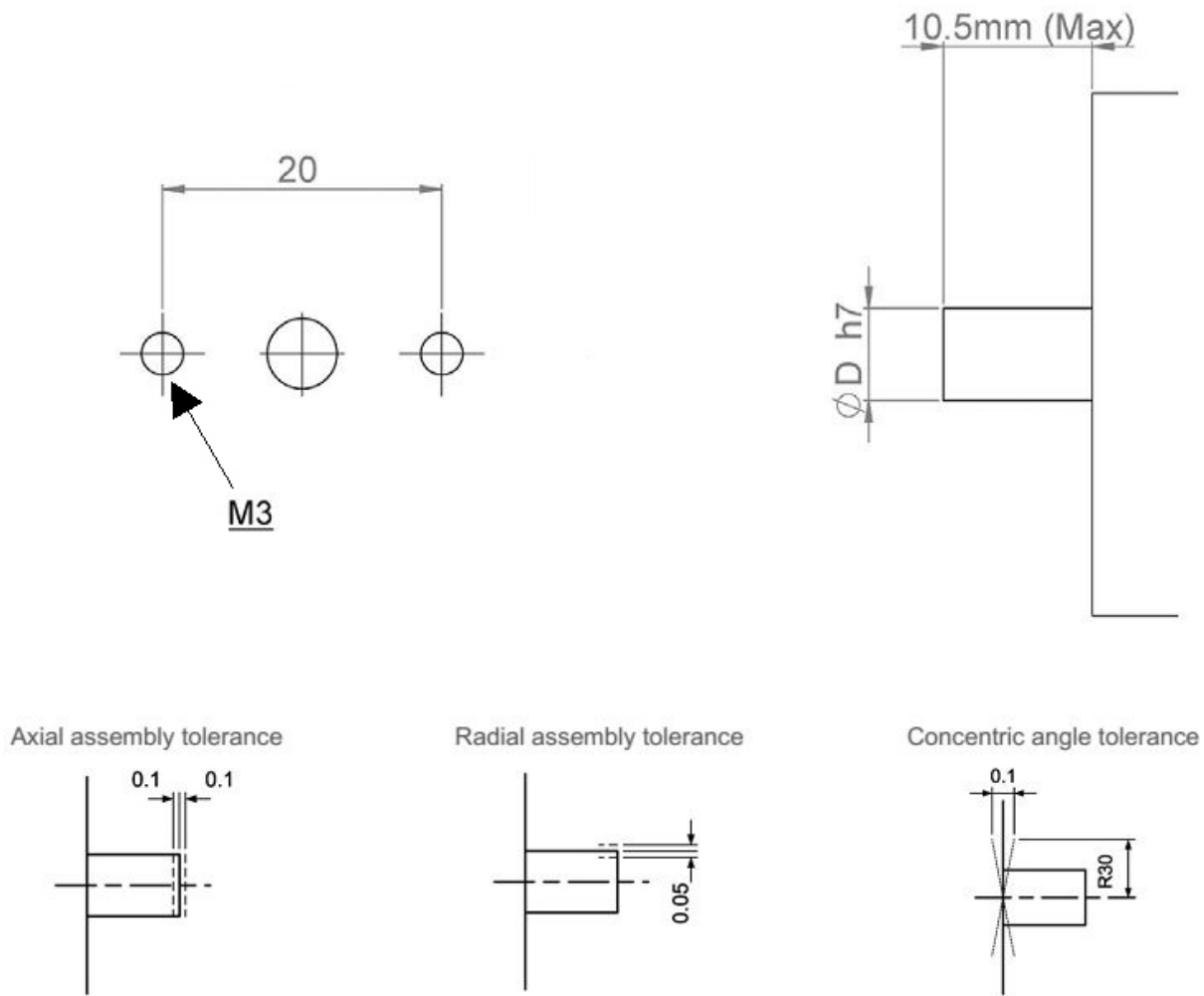

Figure 4: Required dimensions for motor assembly (units = mm) / $D = 5\text{mm}$ or 6.35mm



3 Figures Index

1 Connection and circuit diagram for the line driver outputs	6	4 Required dimensions for motor assembly (units = mm) / D = 5mm or 6.35mm	9
2 Example wave form for CCW rotation	7		
3 Bottom view, side view, and cut view (units = mm)	8		



4 Tables Index

1 Order codes	3	5 Connector and cable pinning and signals	6
2 Electrical Characteristics	4	6 Hardware Revision	14
3 Mechanical Specifications	4	7 Document Revision	14
4 Environmental Specifications	5		



5 Supplemental Directives

5.1 Producer Information

5.2 Copyright

TRINAMIC owns the content of this user manual in its entirety, including but not limited to pictures, logos, trademarks, and resources. © Copyright 2020 TRINAMIC. All rights reserved. Electronically published by TRINAMIC, Germany.

Redistributions of source or derived format (for example, Portable Document Format or Hypertext Markup Language) must retain the above copyright notice, and the complete Datasheet User Manual documentation of this product including associated Application Notes; and a reference to other available product-related documentation.

5.3 Trademark Designations and Symbols

Trademark designations and symbols used in this documentation indicate that a product or feature is owned and registered as trademark and/or patent either by TRINAMIC or by other manufacturers, whose products are used or referred to in combination with TRINAMIC's products and TRINAMIC's product documentation.

This Hardware Manual is a non-commercial publication that seeks to provide concise scientific and technical user information to the target user. Thus, trademark designations and symbols are only entered in the Short Spec of this document that introduces the product at a quick glance. The trademark designation /symbol is also entered when the product or feature name occurs for the first time in the document. All trademarks and brand names used are property of their respective owners.

5.4 Target User

The documentation provided here, is for programmers and engineers only, who are equipped with the necessary skills and have been trained to work with this type of product.

The Target User knows how to responsibly make use of this product without causing harm to himself or others, and without causing damage to systems or devices, in which the user incorporates the product.

5.5 Disclaimer: Life Support Systems

TRINAMIC Motion Control GmbH & Co. KG does not authorize or warrant any of its products for use in life support systems, without the specific written consent of TRINAMIC Motion Control GmbH & Co. KG.

Life support systems are equipment intended to support or sustain life, and whose failure to perform, when properly used in accordance with instructions provided, can be reasonably expected to result in personal injury or death.

Information given in this document is believed to be accurate and reliable. However, no responsibility is assumed for the consequences of its use nor for any infringement of patents or other rights of third parties which may result from its use. Specifications are subject to change without notice.

5.6 Disclaimer: Intended Use

The data specified in this user manual is intended solely for the purpose of product description. No representations or warranties, either express or implied, of merchantability, fitness for a particular purpose



or of any other nature are made hereunder with respect to information/specification or the products to which information refers and no guarantee with respect to compliance to the intended use is given.

In particular, this also applies to the stated possible applications or areas of applications of the product. TRINAMIC products are not designed for and must not be used in connection with any applications where the failure of such products would reasonably be expected to result in significant personal injury or death (safety-Critical Applications) without TRINAMIC's specific written consent.

TRINAMIC products are not designed nor intended for use in military or aerospace applications or environments or in automotive applications unless specifically designated for such use by TRINAMIC. TRINAMIC conveys no patent, copyright, mask work right or other trade mark right to this product. TRINAMIC assumes no liability for any patent and/or other trade mark rights of a third party resulting from processing or handling of the product and/or any other use of the product.

5.7 Collateral Documents & Tools

This product documentation is related and/or associated with additional tool kits, firmware and other items, as provided on the product page at: www.trinamic.com.



6 Revision History

6.1 Hardware Revision

Version	Date	Author	Description
1.00	01.03.2017	TMC	Initial release

Table 6: Hardware Revision

6.2 Document Revision

Version	Date	Author	Description
1.00	23.02.2017	SK	Initial release.
1.01	14.08.2017	SK	Correct hollow diameter and resolution on page 4.
1.10	11.10.2017	SK	Electrical ratings updated.
1.11	21.12.2017	OK	Resolution entries clarified.
1.12	27.08.2018	SK	Information on required shaft diameter D added.
1.30	24.09.2018	SK	Added 4.096 resolution versions.
1.31	29.11.2018	SK	Waveform image description updated.
1.32	14.12.2018	SK	Updated order codes.
1.40	01.07.2019	SK	Removed Start Torque Parameter since it is not needed/defined for simply encoder kit without bearing inside.
1.50	23.08.2019	SK	Order Codes updated.
1.60	10.08.2020	SK	Corrected the lpr value.

Table 7: Document Revision

